

# Hyper 5 mm (T1 3/4) LED, Non Diffused Enhanced optical Power LED (ATON®)

## LW 541C



### Vorläufige Daten / Preliminary Data

#### Besondere Merkmale

- **Gehäusetypp:** nicht eingefärbtes, klares 5 mm (T1<sup>3/4</sup>) Gehäuse
- **Besonderheit des Bauteils:** enge Abstrahlcharakteristik; Lötspieße ohne Aufsetzebene
- **Farbort:** x = 0.32, y = 0.31 nach CIE 1931 (weiß)
- **typ. Farbtemperatur:** 6500 K
- **Farbwiedergabeindex:** 80
- **Abstrahlwinkel:** 20°
- **Technologie:** InGaN
- **optischer Wirkungsgrad:** 12 lm/W
- **Gruppierungsparameter:** Lichtstärke, Farbort
- **Lötmethode:** Wellenlöten (TTW)
- **Verpackung:** Schüttgut, gegurtet lieferbar
- **ESD-Festigkeit:** ESD-sicher bis 2 kV nach EOS/ESD-5.1-1993

#### Anwendungen

- Informationsanzeigen im Außenbereich
- optischer Indikator
- Signal- und Symbolleuchten
- Markierungsbeleuchtung (z.B. Stufen, Fluchtwege, u.ä.)
- Effektbeleuchtung (z.B. Sternenhimmel)
- Ersatz von Miniaturlampen
- Möbelbeleuchtung (z.B. Vitrinen)

#### Features

- **package:** colorless, clear 5 mm (T1<sup>3/4</sup>) package
- **feature of the device:** narrow viewing angle, solder leads without stand-off
- **color coordinates:** x = 0.32, y = 0.31 acc. to CIE 1931 (white)
- **typ. color temperature:** 6500 K
- **color reproduction index:** 80
- **viewing angle:** 20°
- **technology:** InGaN
- **optical efficiency:** 12 lm/W
- **grouping parameter:** luminous intensity, color coordinates
- **soldering methods:** TTW soldering
- **packing:** bulk, available taped on reel
- **ESD-withstand voltage:** up to 2 kV acc. to EOS/ESD-5.1-1993

#### Applications

- outdoor displays
- optical indicators
- signal and symbol luminaire
- marker lights (e.g. steps, exit ways, etc.)
- lighting for special effects (e.g. starry sky)
- substitute for miniature flashlight
- furniture lighting (e.g. glass cupboards)

Typ	Emissions- farbe	Gehäusefarbe	Lichtstärke	Lichtstrom	Bestellnummer
Type	Color of Emission	Color of Package	Luminous Intensity $I_F = 20 \text{ mA}$ $I_V \text{ (mcd)}$	Luminous Flux $I_F = 20 \text{ mA}$ $\Phi_V \text{ (lm)}$	Ordering Code
LW 541C-BWCW-35	white	colorless clear	1800 ...4500	950(typ.)	Q62703Q6401
LW 541C-CWDW-35			2800 ...7100	1500(typ.)	Q65110A0630

Anm.: -35 Farbselektiert nach Farbortgruppen (siehe **Seite 5**).

*Die Standardlieferform von Serientypen beinhaltet eine untere bzw. eine obere Familiengruppe oder mindestens zwei Einzelgruppen.*

*In einer Verpackungseinheit / Gurt ist immer nur eine Helligkeitsgruppe enthalten.*

*Die technologiebedingte Helligkeits-Streuung der heutigen LED-Herstellprozesse über einen längeren Fertigungszeitraum (Halbleitermaterial - Chipherstellung - Montageprozess) erlaubt keine Zusage einer einzelnen Helligkeitsgruppe. Daher müssen mindestens zwei Helligkeitsgruppen vorgesehen werden!*

Note: -35 Color selection acc. to Chromaticity coordinate groups (see **page 5**)

*The standard shipping format for serial types includes a lower or upper family group or at least two individual groups.*

*No packing unit / tape ever contains more than one luminous intensity group.*

*Luminosity variations caused by the technology used in current LED manufacturing processes over a protracted manufacturing period (semiconductor material - chip fabrication - assembly process) mean that it is not possible to assign LEDs to a single luminous intensity group. For this reason at least two luminous intensity groups must be provided!*

**Grenzwerte**  
**Maximum Ratings**

Bezeichnung Parameter	Symbol Symbol	Wert Value	Einheit Unit
Betriebstemperatur Operating temperature range	$T_{op}$	- 40 ... + 100	°C
Lagertemperatur Storage temperature range	$T_{stg}$	- 40 ... + 100	°C
Sperrschichttemperatur Junction temperature	$T_j$	+ 100	°C
Durchlassstrom Forward current	$I_F$	20	mA
Stoßstrom Surge current $t \leq 10 \mu s, D = 0.005$	$I_{FM}$	200	mA
Sperrspannung <sup>1)</sup> Reverse voltage	$V_R$	5	V
Leistungsaufnahme Power consumption $T_A \leq 25 \text{ °C}$	$P_{tot}$	85	mW
Wärmewiderstand <sup>2)</sup> Thermal resistance Sperrschicht/Umgebung Junction/ambient Sperrschicht/Löt­pad Junction/solder point Montage auf PC-Board FR 4 (Padgröße $\geq 16 \text{ mm}^2$ ) mounted on PC board FR 4 (pad size $\geq 16 \text{ mm}^2$ ) Minimale Beinchenlänge Minimum lead length	$R_{th JA}$  $R_{th JS}$	450  230	K/W  K/W

<sup>1)</sup> für kurzzeitigen Betrieb geeignet / suitable for short term application

<sup>2)</sup>  $R_{th}$  erhöht sich um 13 K/W pro mm Beinchenlänge.  
Each additional 1 mm of lead length increases  $R_{th}$  by 13 K/W.

Kennwerte ( $T_A = 25\text{ °C}$ )

## Characteristics

Bezeichnung Parameter	Symbol Symbol	Wert Value	Einheit Unit
Farbkoordinate x nach CIE 1931 <sup>1)</sup> Chromaticity coordinate x acc. to CIE 1931 $I_F = 20\text{ mA}$	x	0.32	–
Farbkoordinate y nach CIE 1931 <sup>1)</sup> Chromaticity coordinate y acc. to CIE 1931 $I_F = 20\text{ mA}$	y	0.31	–
Abstrahlwinkel bei 50 % $I_V$ (Vollwinkel) Viewing angle at 50 % $I_V$	2 $\phi$	20	Grad deg.
Durchlassspannung <sup>2)</sup> (min.) Forward voltage (typ.) $I_F = 20\text{ mA}$ (max.)	$V_F$ $V_F$ $V_F$	3.0 3.6 4.1	V V V
Sperrstrom (typ.) Reverse current (max.) $V_R = 5\text{ V}$	$I_R$ $I_R$	0.01 10	$\mu\text{A}$ $\mu\text{A}$
Temperaturkoeffizient von x Temperature coefficient of x $I_F = 20\text{ mA}; -10\text{ °C} \leq T \leq 100\text{ °C}$	$TC_X$	–0.1	$10^{-3}/\text{K}$
Temperaturkoeffizient von y Temperature coefficient of y $I_F = 20\text{ mA}; -10\text{ °C} \leq T \leq 100\text{ °C}$	$TC_Y$	–0.2	$10^{-3}/\text{K}$
Temperaturkoeffizient von $V_F$ Temperature coefficient of $V_F$ ) $I_F = 20\text{ mA}; -10\text{ °C} \leq T \leq 100\text{ °C}$	$TC_V$	–3.0	mV/K
Optischer Wirkungsgrad (typ.) Optical efficiency $I_F = 20\text{ mA}$	$\eta_{\text{opt}}$	12	lm/W

<sup>1)</sup> Farbortgruppen werden mit einer Stromeinprägungsdauer von 25 ms und einer Genauigkeit von  $\pm 0,01$  ermittelt.  
Chromaticity coordinate groups are tested at a current pulse duration of 25 ms and a tolerance of  $\pm 0.01$ .

<sup>2)</sup> Durchlassspannungsgruppen werden mit einer Stromeinprägungsdauer von 1 ms und einer Genauigkeit von  $\pm 0,1\text{ V}$  ermittelt.  
Forward voltage groups are tested at a current pulse duration of 1 ms and a tolerance of  $\pm 0.1\text{ V}$ .

1) Farbortgruppen  
Chromaticity coordinate groups

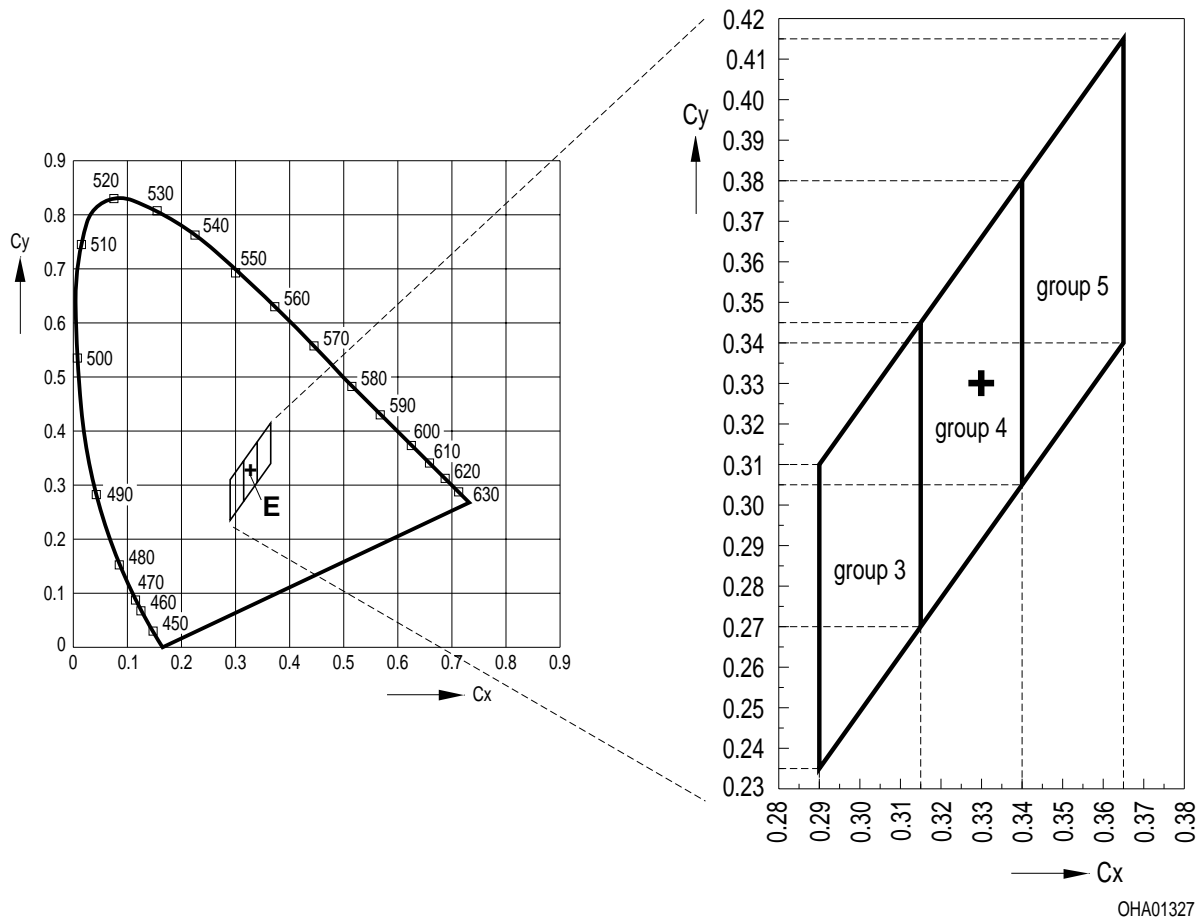

**Helligkeits-Gruppierungsschema**  
**Luminous Intensity Groups**

Lichtgruppe Luminous Intensity Group	Lichtstärke Luminous Intensity $I_V$ (mcd)	Lichtstrom Luminous Flux $\Phi_V$ (mlm)
BW	1800 ... 2800	690 (typ.)
CW	2800 ... 4500	1090 (typ.)
DW	4500 ... 7100	1750 (typ.)

Helligkeitswerte werden mit einer Stromeinprägedauer von 25 ms und einer Genauigkeit von  $\pm 11\%$  ermittelt.  
Luminous intensity is tested at a current pulse duration of 25 ms and a tolerance of  $\pm 11\%$ .

**Gruppenbezeichnung auf Etikett**  
**Group Name on Label**

Beispiel: BW-3

Example: BW-3

Lichtgruppe Luminous Intensity Group	Farbortgruppe Chromaticity Coordinate Group
BW	3

Relative spektrale Emission  $I_{rel} = f(\lambda)$ ,  $T_A = 25\text{ °C}$ ,  $I_F = 20\text{ mA}$

**Relative Spectral Emission**

$V(\lambda)$  = spektrale Augenempfindlichkeit

Standard eye response curve

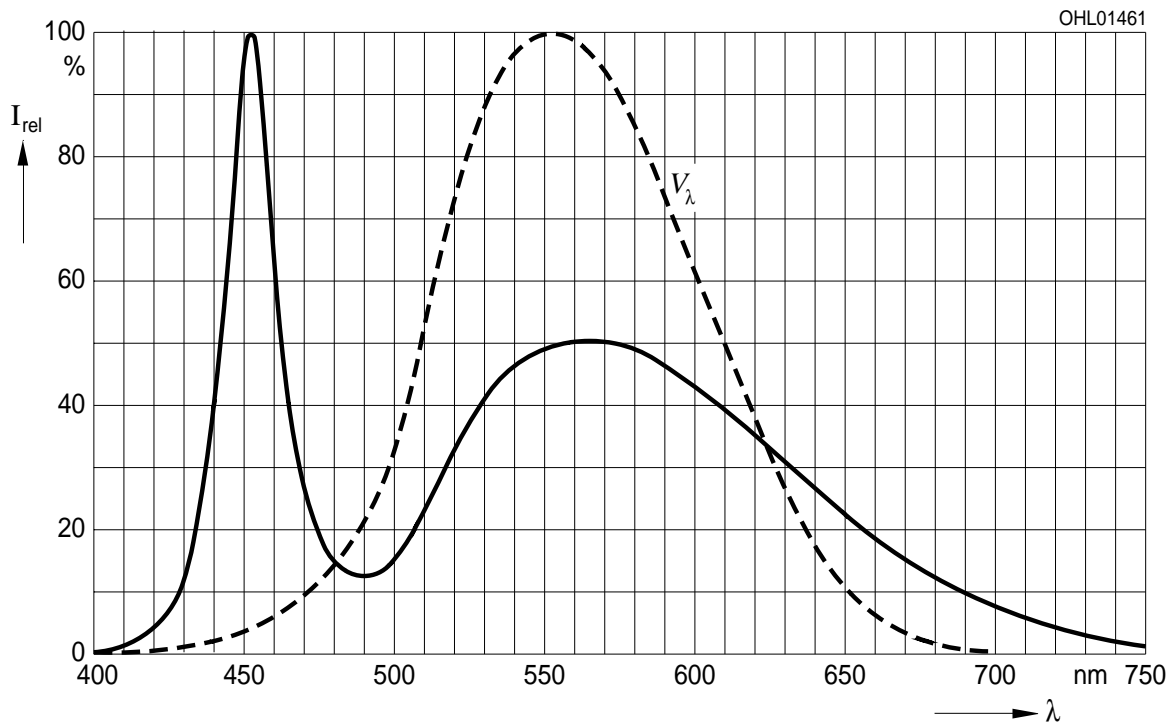

Abstrahlcharakteristik  $I_{rel} = f(\varphi)$

**Radiation Characteristic**

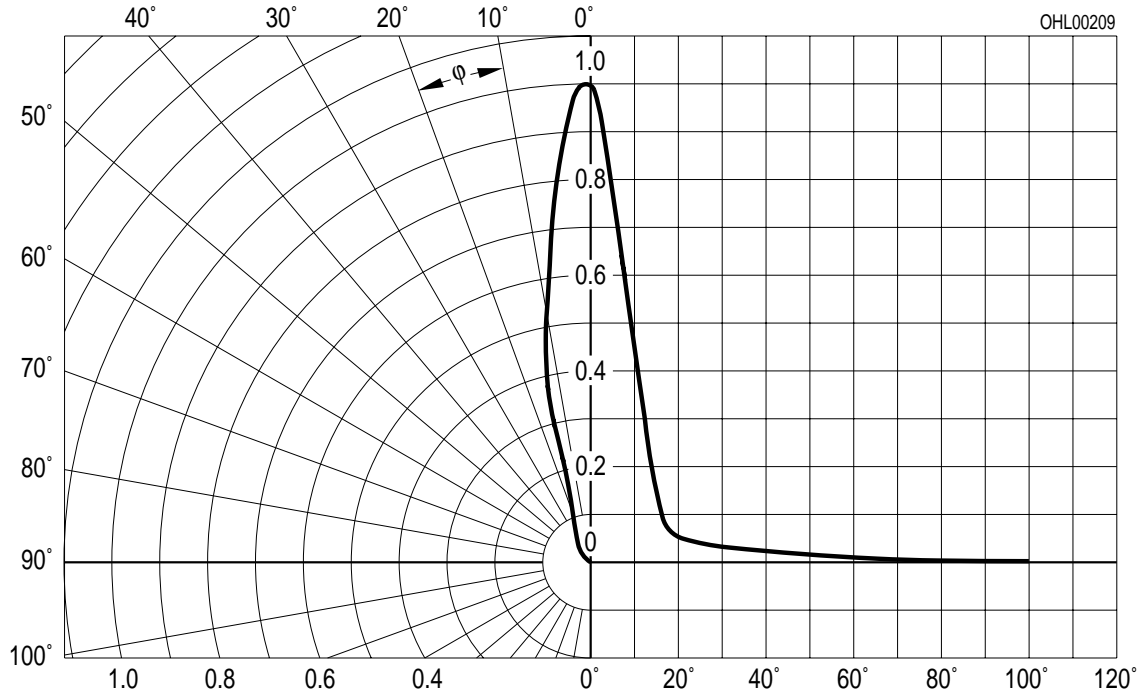

**Durchlassstrom  $I_F = f(V_F)$**   
**Forward Current**  
 $T_A = 25\text{ }^\circ\text{C}$

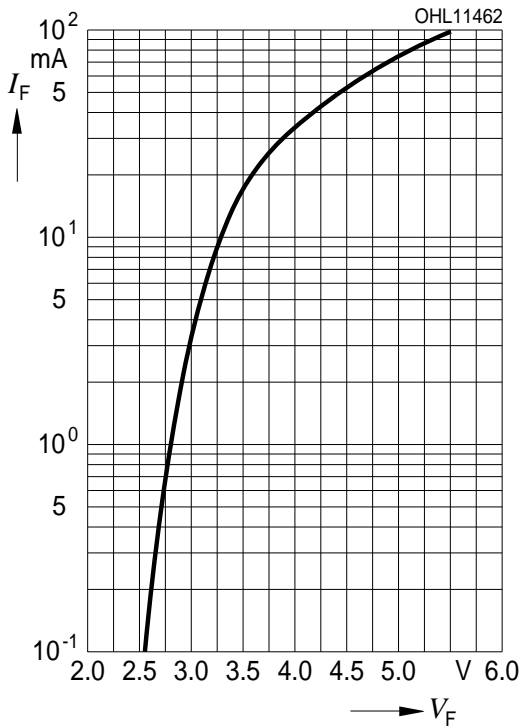

**Relative Lichtstärke  $I_V/I_{V(20\text{ mA})} = f(I_F)$**   
**Relative Luminous Intensity**  
 $T_A = 25\text{ }^\circ\text{C}$

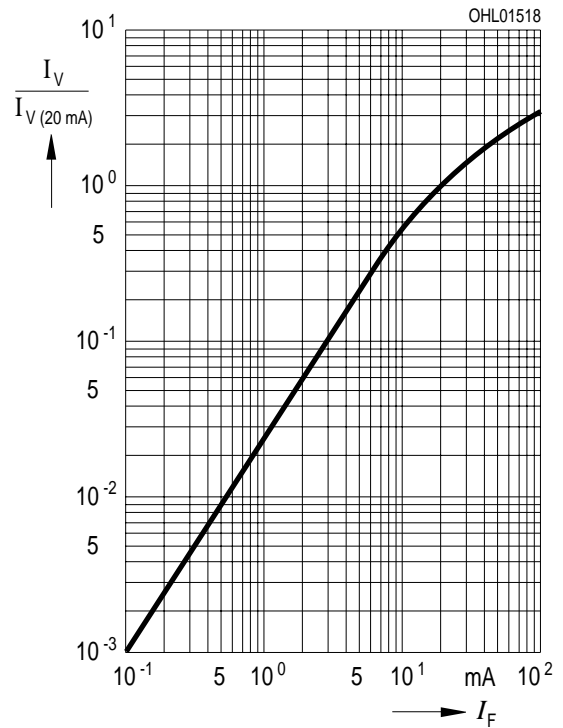

**Maximal zulässiger Durchlassstrom**  
**Max. Permissible Forward Current**  
 $I_F = f(T_A)$

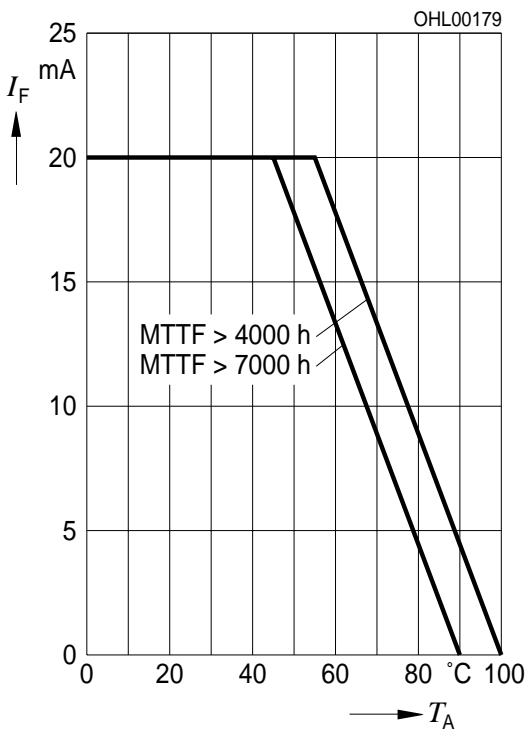

**Maximal zulässiger Durchlassstrom**  
**Max. Permissible Forward Current**  
 $I_F = f(T_S)$

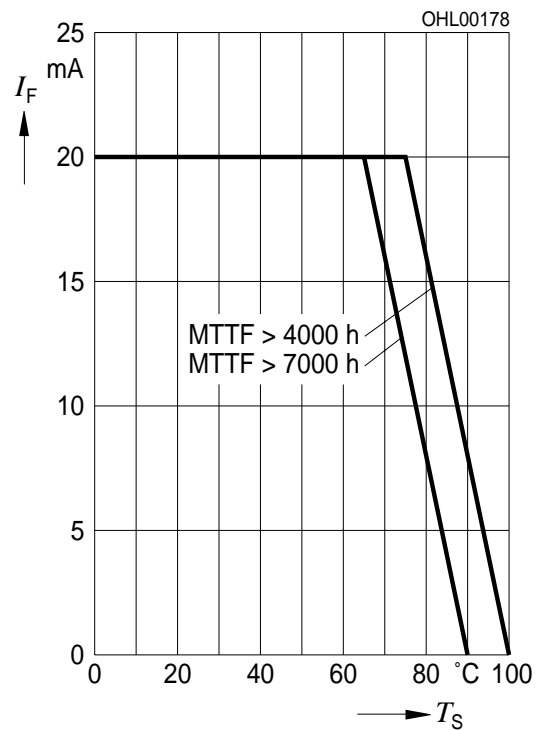



**Farbortverschiebung  $x, y = f(I_F)$**   
**Chromaticity Coordinate Shift**  
 $T_A = 25\text{ °C}$

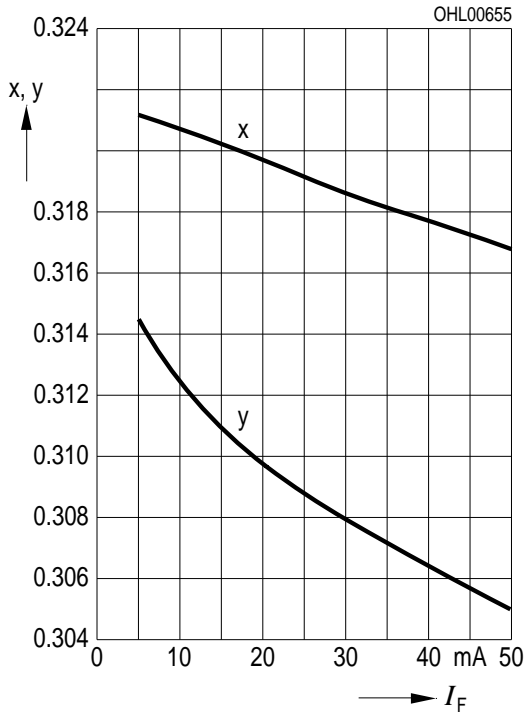

**Relative Lichtstärke  $I_V/I_{V(25\text{ °C})} = f(T_A)$**   
**Relative Luminous Intensity**  
 $I_F = 20\text{ mA}$

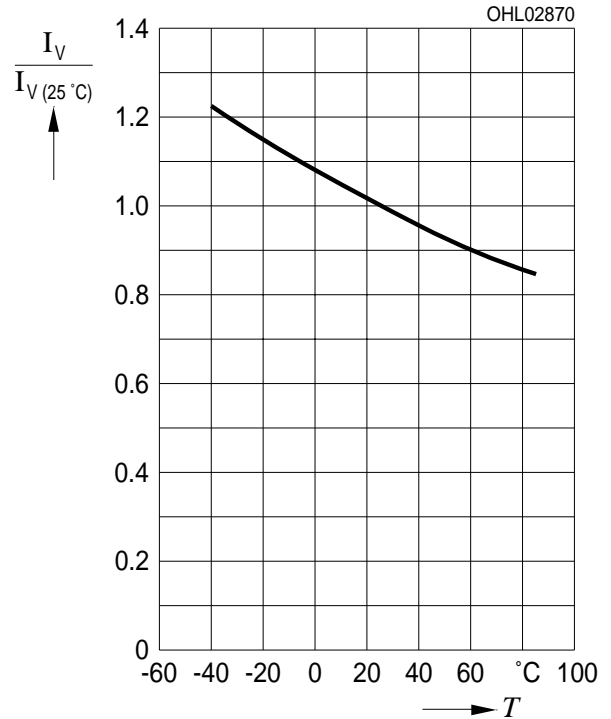

**Zulässige Impulsbelastbarkeit  $I_F = f(t_p)$**   
**Permissible Pulse Handling Capability**  
 Duty cycle  $D = \text{parameter}$ ,  $T_A = 25\text{ °C}$

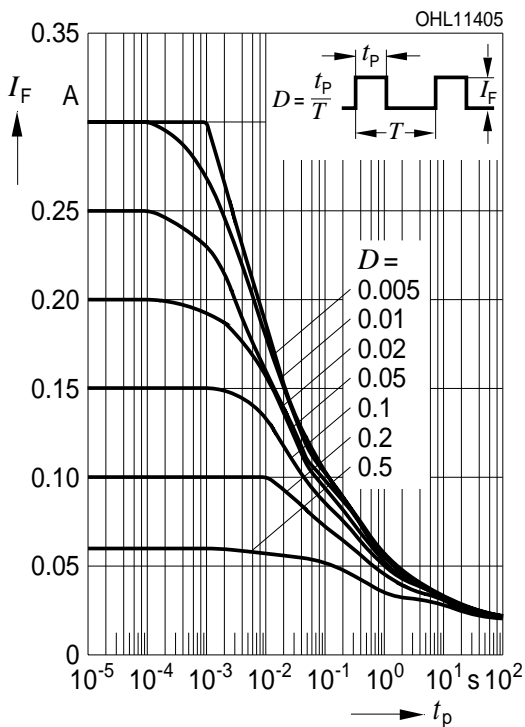

**Zulässige Impulsbelastbarkeit  $I_F = f(t_p)$**   
**Permissible Pulse Handling Capability**  
 Duty cycle  $D = \text{parameter}$ ,  $T_A = 85\text{ °C}$

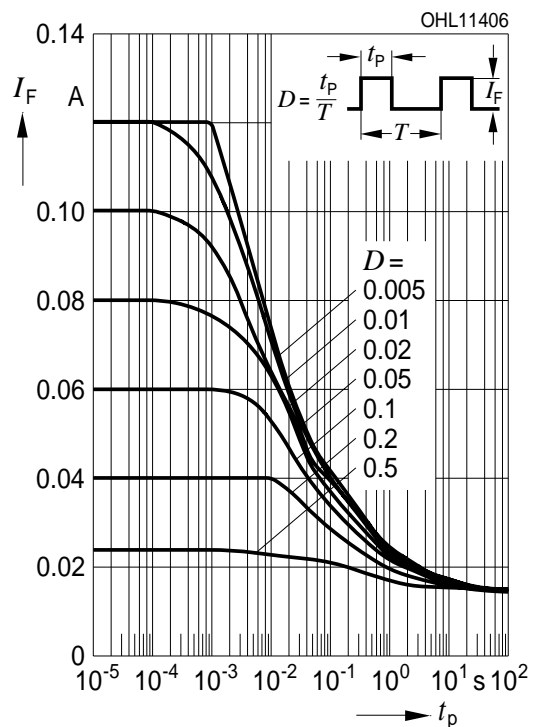

**Maßzeichnung**  
**Package Outlines**

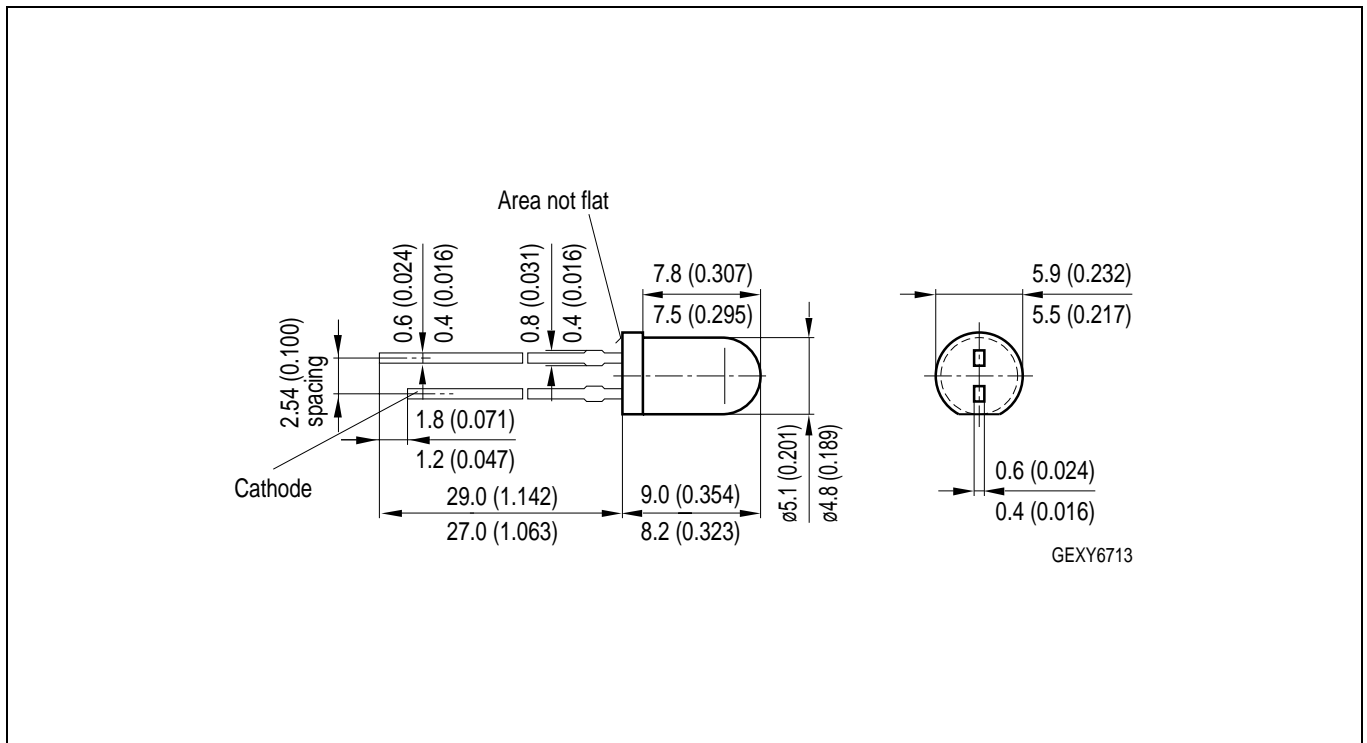

Maße werden wie folgt angegeben: mm (inch) / Dimensions are specified as follows: mm (inch).

**Kathodenkennung:** kürzerer Lötspieß  
**Cathode mark:** short solder lead  
**Gewicht / Approx. weight:** 0.35 g

**Lötbedingungen**  
**Soldering Conditions**

**Wellenlöten (TTW) (nach CECC 00802)**  
**TTW Soldering (acc. to CECC 00802)**

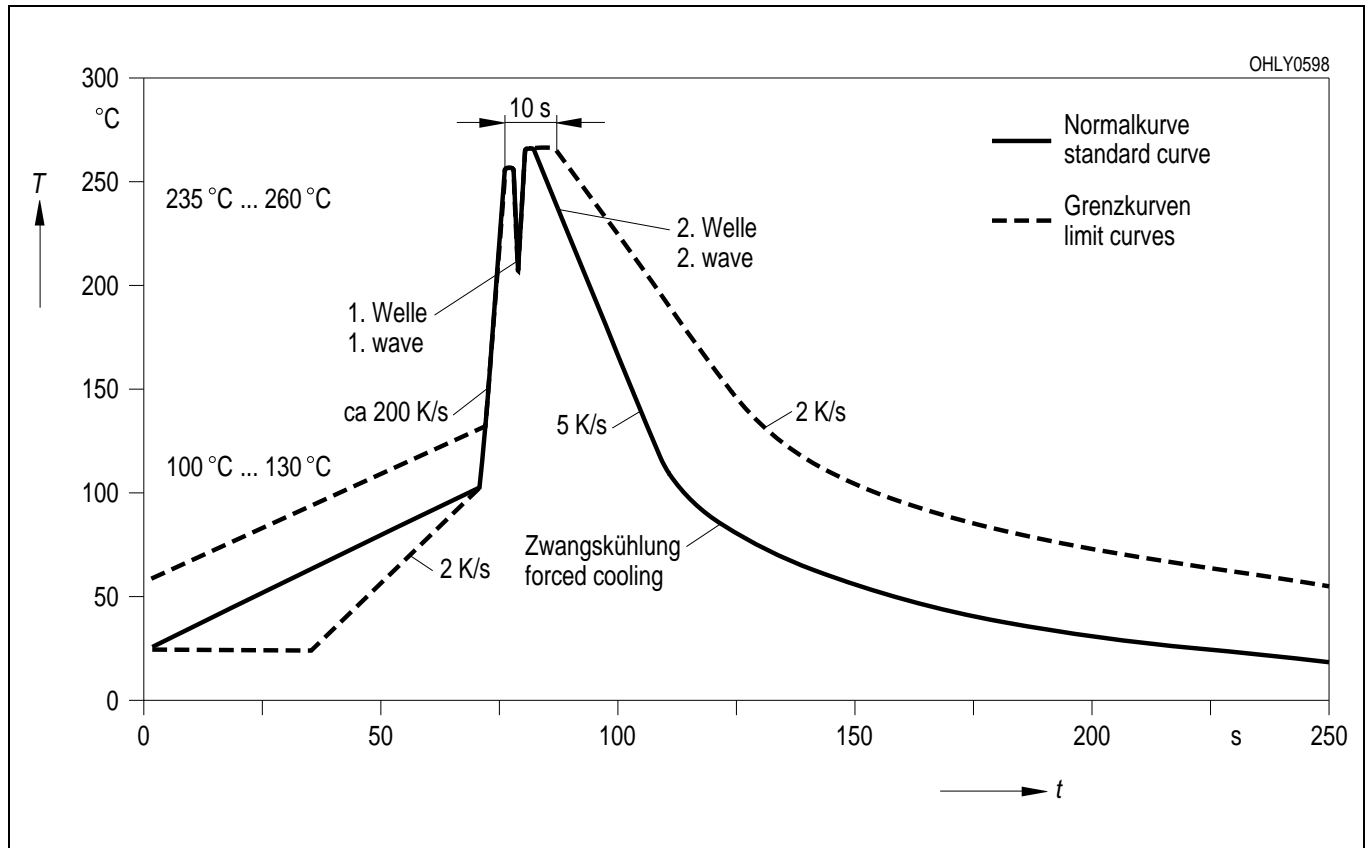

**Empfohlenes Lötpadesign** Wellenlöten (TTW)  
**Recommended Solder Pad** TTW Soldering

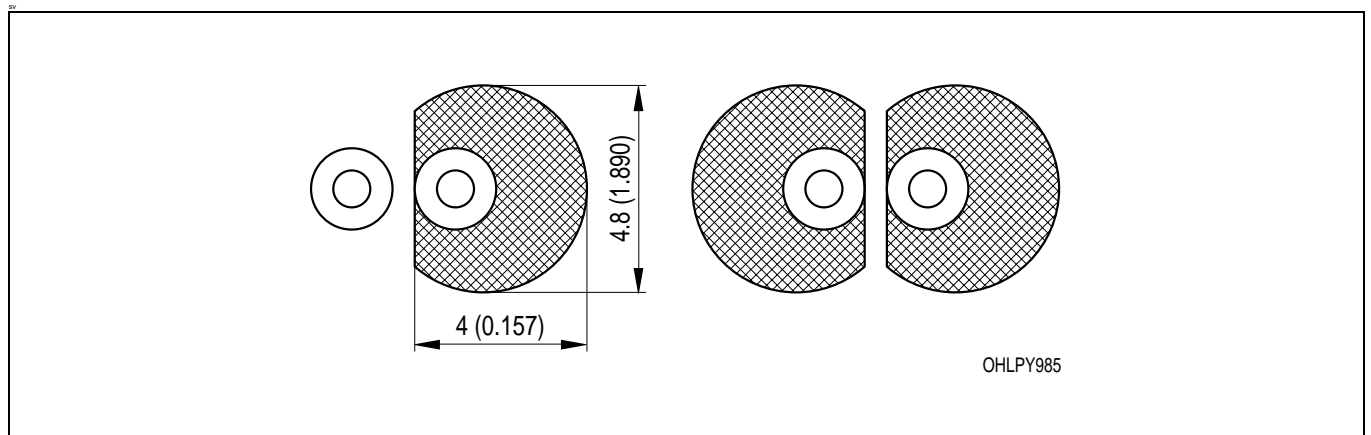

Maße werden wie folgt angegeben: mm (inch) / Dimensions are specified as follows: mm (inch).

<b>Revision History: 2003-03-04</b>		<b>Date of change</b>
Previous Version: 2002-11-28		
<b>Page</b>	<b>Subjects (major changes since last revision)</b>	
3	thermal resistance (footnote)	
4	value (forward voltage)	
2	change grouping from ABBB to AWBW and from BBCB to BWCW	
6	change grouping from half groups to single groups acc. to page 2	
3	power consumption from 90 mW to 85 mW	
8	diagram luminous intensity from OHL01462 to OHL11462	
2	value of $R_{th}$ from 470 to 450 K/W	
9	diagram pulse handling from OHL01405 to OHL00064 and from OHL01406 to OHL00060	
12	annotations	2002-07-25
9	diagram pulse handling (25°C) OHL00064 to OHL11405	2002-08-13
9	diagram pulse handling (85°C) OHL00060 to OHL11406	2002-08-13
3	reverse voltage (footnote)	2002-08-21
2, 5	new luminous intensity groups and new ordering codes	2002-11-18
12	new patent no.	2003-03-04

---

**Patent List**

---

**Patent No.**

---

US 6 066 861, US 6 277 301, US 6 245 259

---

**Published by OSRAM Opto Semiconductors GmbH****Wernerwerkstrasse 2, D-93049 Regensburg****© All Rights Reserved.****Attention please!**

The information describes the type of component and shall not be considered as assured characteristics.

All typical data and graphs are basing on representative samples, but don't represent the production range. If requested, e.g. because of technical improvements, these typ. data will be changed without any further notice.

Terms of delivery and rights to change design reserved. Due to technical requirements components may contain dangerous substances. For information on the types in question please contact our Sales Organization.

If printed or downloaded, please find the latest version in the Internet.

**Packing**

Please use the recycling operators known to you. We can also help you – get in touch with your nearest sales office. By agreement we will take packing material back, if it is sorted. You must bear the costs of transport. For packing material that is returned to us unsorted or which we are not obliged to accept, we shall have to invoice you for any costs incurred.

**Components used in life-support devices or systems must be expressly authorized for such purpose!** Critical components <sup>1</sup> may only be used in life-support devices or systems <sup>2</sup> with the express written approval of OSRAM OS.

<sup>1</sup> A critical component is a component used in a life-support device or system whose failure can reasonably be expected to cause the failure of that life-support device or system, or to affect its safety or the effectiveness of that device or system.

<sup>2</sup> Life support devices or systems are intended (a) to be implanted in the human body, or (b) to support and/or maintain and sustain human life. If they fail, it is reasonable to assume that the health of the user may be endangered.