



VTL5C1, 5C2 ANALOG OPTICAL ISOLATORS

Description

The VTL5C1 offers 100 db dynamic range, fast response time and very high dark resistance.

The VTL5C2 features a very steep slope, low temperature coefficient of resistance and a small light history memory.

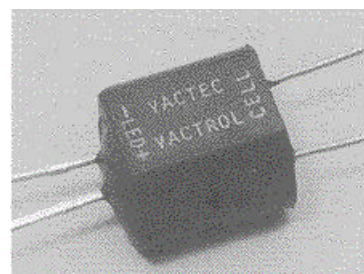

Absolute Maximum Ratings @ 25°C	
Max Temperatures: Storage and Operating: -40°C to 75°C	LED Forward Voltage Drop @ 20 mA: 2.0V (1.65V Typ.)
Cell Power: 175 mW Derate above 30°C: 3.9 mW/°C	Min. Isolation Voltage @ 70% Rel. Humidity: 2500 VRMS
LED Current: 40 mA (1) Derate above 30°C: 0.9 mA/°C	Output Cell Capacitance: 5.0 pF
LED Reverse Breakdown Voltage: 3.0V	Cell Voltage: 100V (VTL5C1), 200V (VTL5C2)
	Input-Output Coupling Capacitance: 0.5 pF

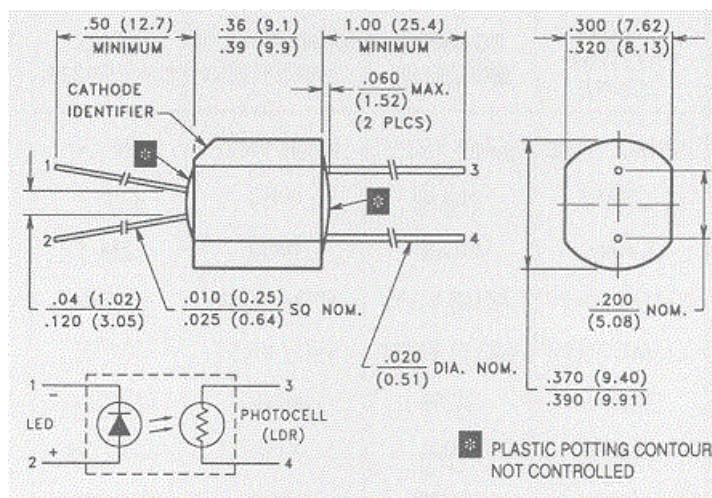

Part Nubmer	Material Type	ON Resistance (2)		OFF (3) Resistance @ 10 sec. (Min.)	Slope (Typ.) R_{DARK} $R @ .5 mA$ $R @ 5 mA$	Dynamic Range (Typ.) $\frac{R_{DARK}}{R @ 20 mA}$	Response Time (4)	
		Input Current	Dark Adapted (Typ.)				Turn-on to 63% Final R_{ON} (Typ.)	Turn-off (Decay) to 100k Ω (Max.)
VTL5C1	1	1mA 10mA 40mA	20k Ω 600 Ω 200 Ω	50 M Ω	15	100 db	2.5 ms	35 ms
VTL5C2	0	1mA 10mA 40mA	5.5k Ω 800 Ω 200 Ω	1 M Ω	24	69 db	3.5 ms	500 ms

Typical Performance Curves

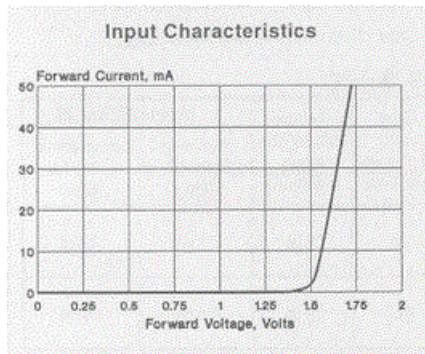
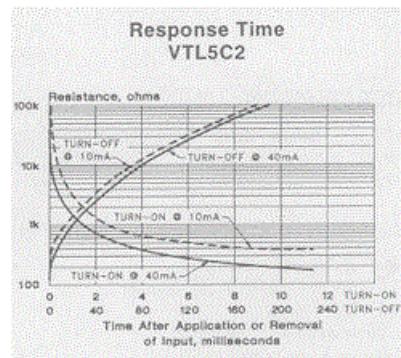
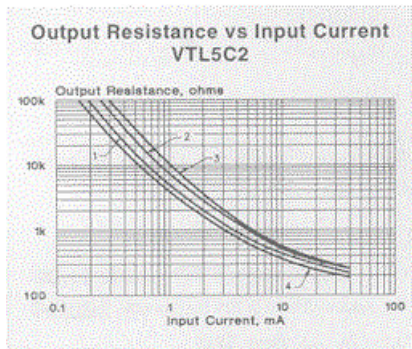
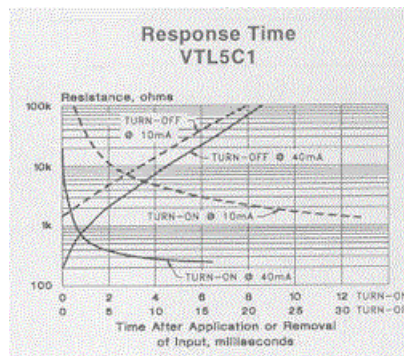
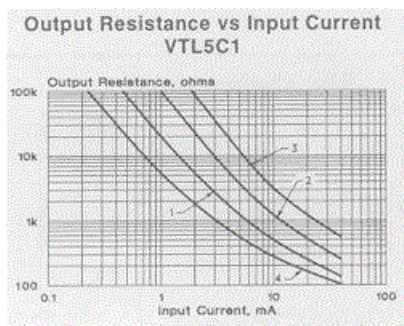

Notes:

- At 1.0 mA and below, units may have substantially higher resistance than shown in the typical curves. Consult the factory if closely controlled characteristics are required at low input currents.
- Output resistance vs input current transfer curves are given for the following light adapt conditions:
 - 25°C - 24 hours @ no input
 - 25°C - 24 hours @ 40 mA input
 - +50°C - 24 hours @ 40 mA input
 - 20°C - 24 hours @ 40 mA input
- Response time characteristics are based upon test following adapt condition (2) above.

Note: If you accessed this page from within the EG&G Web Site, use your browser navigation back button to return to previous page. If you accessed this site from a Search Engine you can [Go to the EG&G Optoelectronics Product Guide.](#)

For a copy of the original data sheet, or to send comments, E-Mail us at: eod@egginc.com
Or call us at 1-800-775-OPTO (6786).

45 William Street, Wellesley, Massachusetts, U.S.A. All Rights Reserved.