

LM2936 Ultra-Low Quiescent Current 5V Regulator

General Description

The LM2936 ultra-low quiescent current regulator features low dropout voltage and low current in the standby mode. With less than 15 μA quiescent current at a 100 μA load, the LM2936 is ideally suited for automotive and other battery-operated systems. The LM2936 retains all of the features that are common to low dropout regulators including a low dropout PNP pass device, short circuit protection, reverse battery protection, and thermal shutdown. The LM2936 has a 40V operating voltage limit, -40°C to $+125^{\circ}\text{C}$ operating temperature range, and $\pm 3\%$ output voltage tolerance over the entire output current, input voltage, and temperature range. The LM2936 is available in both a TO-92 package and an 8-pin surface mount package with a fixed 5V output.

Features

- Ultra low quiescent current ($I_Q \leq 15 \mu\text{A}$ for $I_O \leq 100 \mu\text{A}$)
- Fixed 5V, 50 mA output
- Output tolerance $\pm 3\%$ over line, load, and temperature
- Dropout voltage typically 200 mV @ $I_O = 50 \text{ mA}$
- Reverse battery protection
- -50V reverse transient protection
- Internal short circuit current limit
- Internal thermal shutdown protection
- 40V operating voltage limit

Typical Application

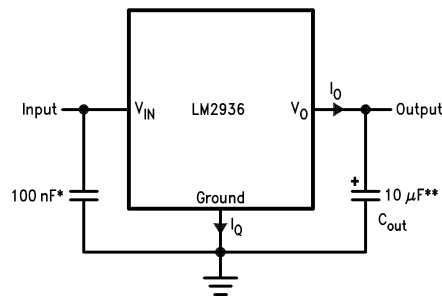

DS009759-1

* Required if regulator is located more than 2" from power supply filter capacitor.

** Required for stability. Must be rated for 10 μF minimum over intended operating temperature range. Effective series resistance (ESR) is critical, see curve. Locate capacitor as close as possible to the regulator output and ground pins. Capacitance may be increased without bound.

Connection Diagrams

TO-92 Plastic Package (Z)

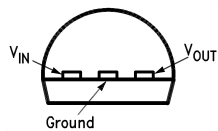

DS009759-2

Bottom View
Order Number LM2936Z-5.0
See NS Package Number Z03A

8-Pin SO (M)

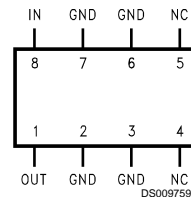

DS009759-6

Top View
Order Number LM2936M-5.0
See NS Package Number M08A

Absolute Maximum Ratings (Note 1)

If Military/Aerospace specified devices are required, please contact the National Semiconductor Sales Office/Distributors for availability and specifications.

Input Voltage (Survival)	+60V, -50V
ESD Susceptability (Note 2)	1900V
Power Dissipation (Note 3)	Internally limited
Junction Temperature (T_{Jmax})	150°C

Storage Temperature Range	-65°C to +150°C
Lead Temperature (Soldering, 10 sec.)	260°C

Operating Ratings

Operating Temperature Range	-40°C to +125°C
Maximum Input Voltage (Operational)	40V

Electrical Characteristics

$V_{IN} = 14V$, $I_O = 10\text{ mA}$, $T_J = 25^\circ\text{C}$, unless otherwise specified. **Boldface** limits apply over entire operating temperature range

Parameter	Conditions	Typical (Note 4)	Tested Limit (Note 5)	Units
Output Voltage	$5.5V \leq V_{IN} \leq 26V$, $I_O \leq 50\text{ mA}$ (Note 6)		4.85	V_{min}
		5		V
			5.15	V_{max}
Line Regulation	$9V \leq V_{IN} \leq 16V$	5	10	mV_{max}
	$6V \leq V_{IN} \leq 40V$, $I_O = 1\text{ mA}$	10	30	
Load Regulation	$100\ \mu\text{A} \leq I_O \leq 5\text{ mA}$	10	30	mV_{max}
	$5\text{ mA} \leq I_O \leq 50\text{ mA}$	10	30	
Output Impedance	$I_O = 30\text{ mAdc}$ and 10 mArms , $f = 1000\text{ Hz}$	450		$m\Omega$
Quiescent Current	$I_O = 100\ \mu\text{A}$, $8V \leq V_{IN} \leq 24V$	9	15	μA_{max}
	$I_O = 10\text{ mA}$, $8V \leq V_{IN} \leq 24V$	0.20	0.50	mA_{max}
	$I_O = 50\text{ mA}$, $8V \leq V_{IN} \leq 24V$	1.5	2.5	mA_{max}
Output Noise Voltage	10 Hz–100 kHz	500		μV_{rms}
Long Term Stability		20		$mV/1000\text{ Hr}$
Ripple Rejection	$V_{ripple} = 1\text{ V}_{rms}$, $f_{ripple} = 120\text{ Hz}$	60	40	dB_{min}
Dropout Voltage	$I_O = 100\ \mu\text{A}$	0.05	0.10	V_{max}
	$I_O = 50\text{ mA}$	0.20	0.40	V_{max}
Reverse Polarity DC Input Voltage	$R_L = 500\Omega$, $V_O \geq -0.3V$		-15	V_{min}
Reverse Polarity Transient Input Voltage	$R_L = 500\Omega$, $T = 1\text{ ms}$	-80	-50	V_{min}
Output Leakage with Reverse Polarity Input	$V_{IN} = -15V$, $R_L = 500\Omega$	-0.1	-600	μA_{max}
Maximum Line Transient	$R_L = 500\Omega$, $V_O \leq 5.5V$, $T = 40\text{ ms}$		60	V_{min}
Short Circuit Current	$V_O = 0V$	120	250	mA_{max}
			65	mA_{min}

Note 1: Absolute Maximum Ratings indicate limits beyond which damage to the device may occur. DC and AC electrical specifications do not apply when operating the device beyond its specified operating ratings.

Note 2: Human body model, 100 pF discharge through a 1.5 k Ω resistor.

Note 3: The maximum power dissipation is a function of T_{Jmax} , θ_{JA} , and T_A . The maximum allowable power dissipation at any ambient temperature is $P_D = (T_{Jmax} - T_A)/\theta_{JA}$. If this dissipation is exceeded, the die temperature will rise above 150°C and the LM2936 will go into thermal shutdown. For the LM2936Z, the junction-to-ambient thermal resistance (θ_{JA}) is 195°C/W. For the LM2936M, θ_{JA} is 160°C/W.

Note 4: Typical values are at 25°C (unless otherwise specified) and represent the most likely parametric norm.

Note 5: Tested limits are guaranteed to National's AOQL (Average Outgoing Quality Level) and 100% tested.

Note 6: To ensure constant junction temperature, pulse testing is used.

Typical Performance Characteristics

Maximum Power Dissipation (TO-92)

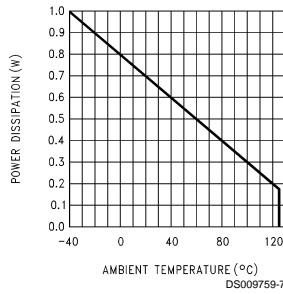

Dropout Voltage

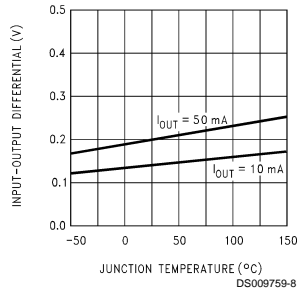

Dropout Voltage

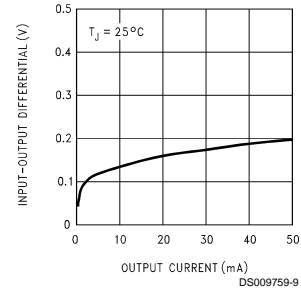

Quiescent Current

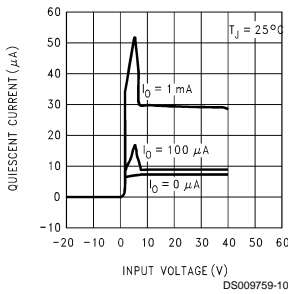

Quiescent Current

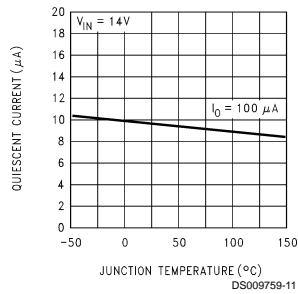

Quiescent Current

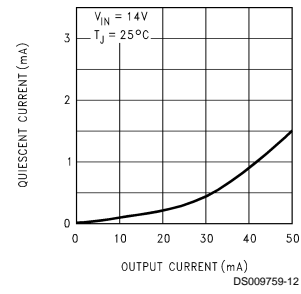

Quiescent Current

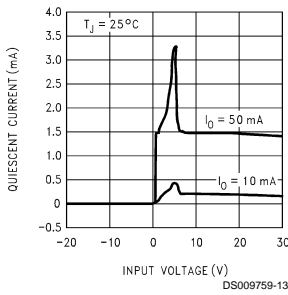

Quiescent Current

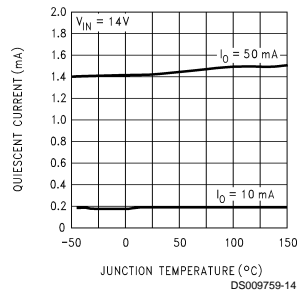

Output Capacitor ESR

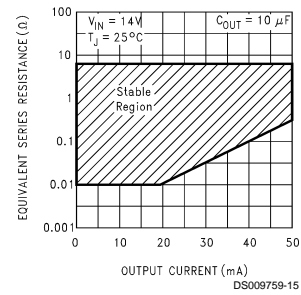

Peak Output Current

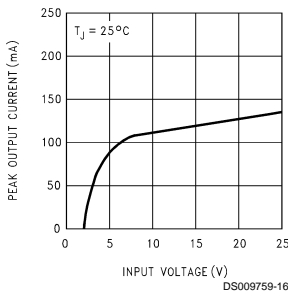

Peak Output Current

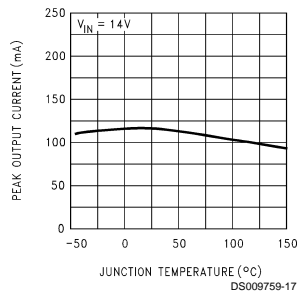

Current Limit

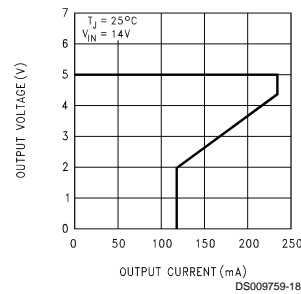

Typical Performance Characteristics (Continued)

Line Transient Response

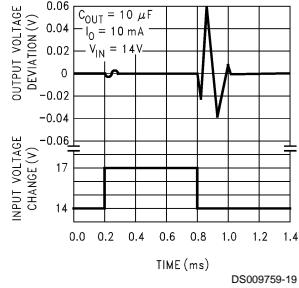

Output at Voltage Extremes

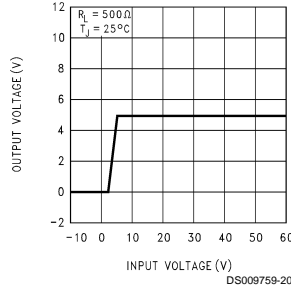

Ripple Rejection

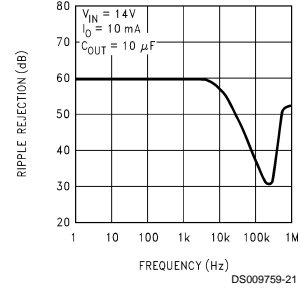

Load Transient Response

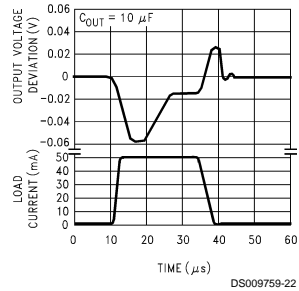

Low Voltage Behavior

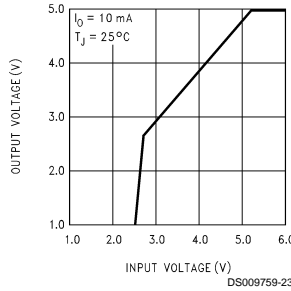

Output Impedance

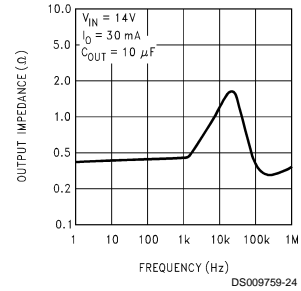

Applications Information

Unlike other PNP low dropout regulators, the LM2936 remains fully operational to 40V. Owing to power dissipation characteristics of the TO-92 package, full output current cannot be guaranteed for all combinations of ambient temperature and input voltage. As an example, consider an LM2936 operating at 25°C ambient. Using the formula for maximum allowable power dissipation given in (Note 3), we find that $P_{Dmax} = 641 \text{ mW}$ at 25°C. Including the small contribution of the quiescent current to total power dissipation the maximum input voltage (while still delivering 50 mA output current) is 17.3V. The device will go into thermal shutdown if it attempts to deliver full output current with an input voltage of more than 17.3V. Similarly, at 40V input and 25°C ambient the LM2936 can deliver 18 mA maximum.

Under conditions of higher ambient temperatures, the voltage and current calculated in the previous examples will drop. For instance, at the maximum ambient of 125°C the LM2936 can only dissipate 128 mW, limiting the input voltage to 7.34V for a 50 mA load, or 3.5 mA output current for a 40V input.

While the LM2936 maintains regulation to 60V, it will not withstand a short circuit above 40V because of safe operating area limitations in the internal PNP pass device. Above 60V the LM2936 will break down with catastrophic effects on the regulator and possibly the load as well. Do not use this device in a design where the input operating voltage may exceed 40V, or where transients are likely to exceed 60V.

Equivalent Schematic Diagram

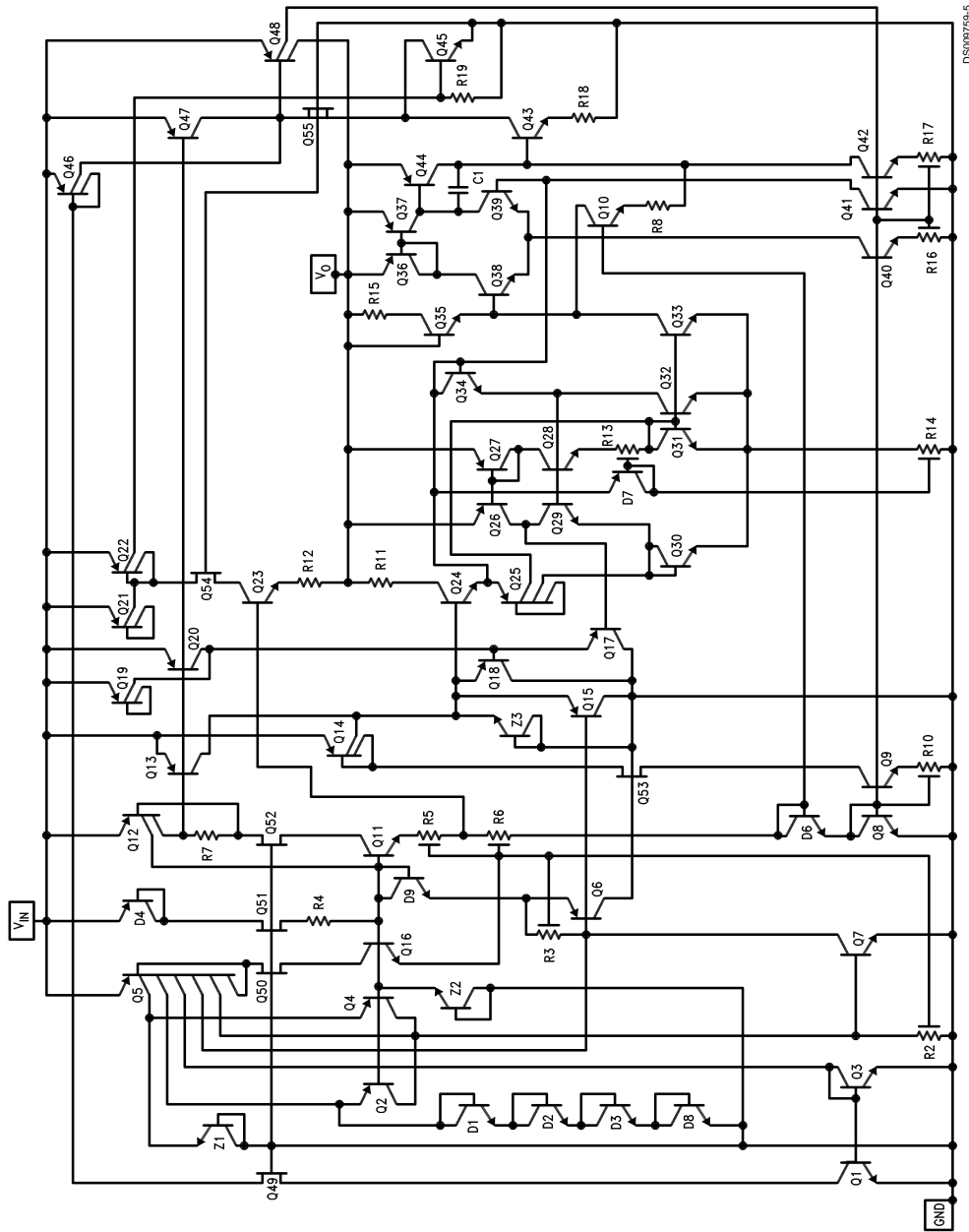

DS90B759-5



Physical Dimensions inches (millimeters) unless otherwise noted

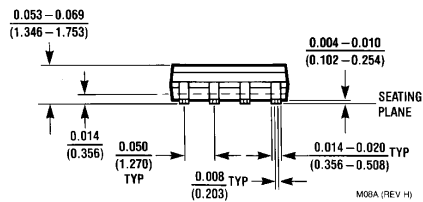
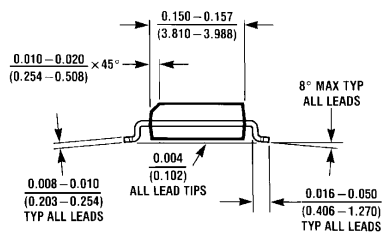
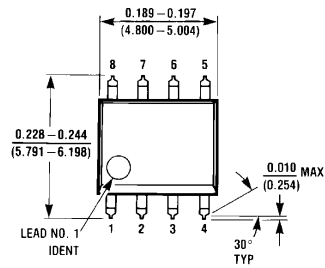

8-Lead Small Outline Molded Package (M)
NS Package Number M08A

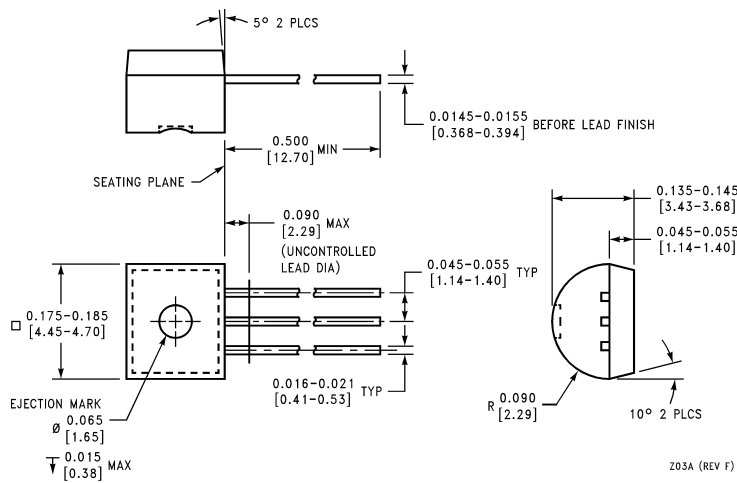

3-Lead TO-92 Plastic Package (Z)
NS Package Number Z03A

LIFE SUPPORT POLICY

NATIONAL'S PRODUCTS ARE NOT AUTHORIZED FOR USE AS CRITICAL COMPONENTS IN LIFE SUPPORT DEVICES OR SYSTEMS WITHOUT THE EXPRESS WRITTEN APPROVAL OF THE PRESIDENT OF NATIONAL SEMICONDUCTOR CORPORATION. As used herein:

1. Life support devices or systems are devices or systems which, (a) are intended for surgical implant into the body, or (b) support or sustain life, and whose failure to perform when properly used in accordance with instructions for use provided in the labeling, can be reasonably expected to result in a significant injury to the user.
2. A critical component in any component of a life support device or system whose failure to perform can be reasonably expected to cause the failure of the life support device or system, or to affect its safety or effectiveness.



National Semiconductor Corporation
Americas
Tel: 1-800-272-9959
Fax: 1-800-737-7018
Email: support@nsc.com

www.national.com

National Semiconductor Europe
Fax: +49 (0) 1 80-530 85 86
Email: europe.support@nsc.com
Deutsch Tel: +49 (0) 1 80-530 85 85
English Tel: +49 (0) 1 80-532 78 32
Français Tel: +49 (0) 1 80-532 93 58
Italiano Tel: +49 (0) 1 80-534 16 80

National Semiconductor Asia Pacific Customer Response Group
Tel: 65-2544466
Fax: 65-2504466
Email: sea.support@nsc.com

National Semiconductor Japan Ltd.
Tel: 81-3-5620-6175
Fax: 81-3-5620-6179