

1μA LOW DROPOUT POSITIVE VOLTAGE REGULATOR

FEATURES

- Extremely Low Power Consumption 1.1μA (Typ.)
- Very Low Dropout Voltage 120mV typ at 100mA
380mV typ at 200mA
- Wide Input Voltage Range 10V (max.)
- High Output Current 250mA ($V_{OUT} = 5.0V$)
- High Accuracy Output Voltage ± 2%
(± 1% Semicustom Version)
- Wide Output Voltage Range 1.1V-6.0V
- Low Power Consumption 1.1μA (Typ.)
- Excellent Line Regulation 0.2%/V (Typ.)
- Package Options .. 3-Pin SOT-23A, SOT-89, TO-92
- Short Circuit Protection
- Custom Voltages Available from 1.1V to 6.0V in 0.1V Steps for a 2%, and 2.0V to 6.0V for a 1% Tolerance

APPLICATIONS

- Battery-Powered Devices
- Cameras and Portable Video Equipment
- Pagers and Cellular Phones
- Solar-Powered Instruments
- Consumer Products

FUNCTIONAL BLOCK DIAGRAM

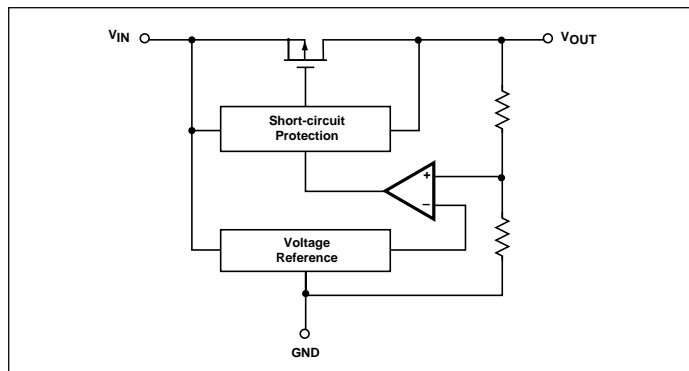

PIN CONFIGURATION

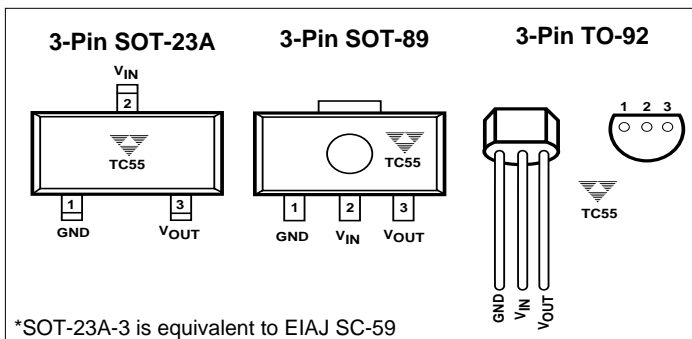

GENERAL DESCRIPTION

The TC55 Series is a family of CMOS low dropout positive voltage regulators which can source up to 250mA of current. The extremely low operating current (1.1μA typical) makes this part the ideal choice for battery operated applications and eliminates the need for an additional shutdown mode. The power consumption of the TC55 is 1000 times lower than in bipolar regulators, significantly extending battery life.

The maximum input voltage of 10V combined with the wide output voltage range (1.1V to 6.0V, in 100mV increments) makes this device suitable for a large variety of applications. Other key features include low dropout voltage (380mV typical at 200mA) and excellent line regulation (0.2%/V). The low voltage differential (dropout voltage) also extends battery operating lifetime and permits high currents in small packages when operated with minimum $V_{IN} - V_{OUT}$ differentials.

The circuit also incorporates short-circuit protection to ensure maximum reliability. The TC55 is stable with an output capacitor (ceramic or tantalum) of only 1μF and is available in a tiny SOT-23A package for space critical applications, as well as in a 3-pin SOT-89 and a 3-pin TO-92 package.

ORDERING INFORMATION

PART CODE TC55 RP XX X X X XX XXX

Output Voltage: _____
 Ex: 20 = 2.0V; 60 = 6.0V 1.0% Tol.
 Ex: 11 = 1.1V; 60 = 6.0V 2.0% Tol.

Extra Feature Code: Fixed: 0 _____

Tolerance: _____
 1 = 1.0% (Custom)
 2 = 2.0% (Standard)

Temperature: E: - 40°C to +85°C _____

Package Type and Pin Count: _____
 CB: 3-Pin SOT-23A (equivalent to EIAJ SC-59)
 MB: 3-Pin SOT-89
 ZB: 3-Pin TO-92

Taping Direction: _____
 TR or 713: Standard Taping
 RT or 723: Reverse Taping
 No suffix: TO-92 Bulk

1 μ A LOW DROPOUT POSITIVE VOLTAGE REGULATOR

TC55 Series

ABSOLUTE MAXIMUM RATINGS*

Item	Code	Ratings	Units
Input Voltage	V_{IN}	+12	V
Output Current	I_{OUT}	$Pd/(V_{IN} - V_{OUT})$	mA
Output Voltage	V_{OUT}	$(V_{SS} - 0.3)$ to $(V_{IN} + 0.3)$	V
Power Dissipation: ($T_A \leq 70^\circ\text{C}$)	3-Pin SOT-23A 3-Pin SOT-89 3-Pin TO-92	Pd 240 400 440	mW
Operating Temperature Range	T_A	- 40 to +85	$^\circ\text{C}$
Storage Temperature Range	T_{stg}	- 65 to +150	$^\circ\text{C}$

TC55RP50 ELECTRICAL CHARACTERISTICS: $V_{OUT(S)} = 5.0\text{V}$, $T_A = 25^\circ\text{C}$ unless otherwise specified (see REMARKS).

Symbol	Parameter	Test Conditions	Min	Typ	Max	Unit
$V_{OUT(A)}$	Output Voltage	$I_{OUT} = 40\text{mA}$ $V_{IN} = 6.0\text{V}$	— 4.90	— 5.0	— 5.10	V
I_{OUTmax}	Maximum Output Current	$V_{IN} = 6.0\text{V}$, $V_{OUT(A)} \geq 4.5\text{V}$	250	—	—	mA
ΔV_{OUT}	Load Regulation	$V_{IN} = 6.0\text{V}$, $1\text{mA} \leq I_{OUT} \leq 100\text{mA}$	—	40	80	mV
V_{dif}	I/O Voltage Difference	$I_{OUT} = 100\text{mA}$ $I_{OUT} = 200\text{mA}$	— —	120 380	300 600	mV
I_{SS}	Current Consumption	$V_{IN} = 6.0\text{V}$	—	1.1	3.0	μA
$\frac{V_{OUT(A)} \cdot 100}{\Delta V_{IN} \cdot V_{OUT(S)}}$	Voltage Regulation	$I_{OUT} = 40\text{mA}$ $6.0\text{V} \leq V_{IN} \leq 10.0\text{V}$	—	0.2	0.3	%/V
V_{IN}	Input Voltage		—	—	10.0	V
$\frac{\Delta V_{OUT(A)} \cdot 10^6}{V_{OUT(S)} \cdot \Delta T_A}$	Temperature Coefficient of Output Voltage	$I_{OUT} = 40\text{mA}$ $-40^\circ\text{C} \leq T_A \leq 85^\circ\text{C}$	—	± 100	—	ppm/ $^\circ\text{C}$
	Long Term Stability	$T_A = 125^\circ\text{C}$, 1000 Hours	—	0.5	—	%

REMARKS:

$V_{OUT(S)}$: Preset value of Output voltage

$V_{OUT(A)}$: Actual value of Output voltage

V_{dif} : Definition of I/O voltage difference = $(V_{IN1} - V_{OUT(A)})$

$V_{OUT(A)}$: Output Voltage when I_{OUT} is fixed and $V_{IN} = V_{OUT(S)} + 1.0\text{V}$

V_{IN1} : Input Voltage when the output voltage is 98% $V_{OUT(A)}$

TC55RP40 ELECTRICAL CHARACTERISTICS: $V_{OUT(S)} = 4.0\text{V}$, $T_A = 25^\circ\text{C}$ unless otherwise specified (see REMARKS).

Symbol	Parameter	Test Conditions	Min	Typ	Max	Unit
$V_{OUT(A)}$	Output Voltage	$I_{OUT} = 40\text{mA}$ $V_{IN} = 5.0\text{V}$	— 3.92	— 4.0	— 4.08	V
I_{OUTmax}	Maximum Output Current	$V_{IN} = 5.0\text{V}$, $V_{OUT(A)} \geq 3.6\text{V}$	200	—	—	mA
ΔV_{OUT}	Load Regulation	$V_{IN} = 5.0\text{V}$, $1\text{mA} \leq I_{OUT} \leq 100\text{mA}$	—	45	90	mV
V_{dif}	I/O Voltage Difference	$I_{OUT} = 100\text{mA}$ $I_{OUT} = 200\text{mA}$	— —	170 400	330 630	mV
I_{SS}	Current Consumption	$V_{IN} = 5.0\text{V}$	—	1.0	2.9	μA
$\frac{\Delta V_{OUT(A)} \cdot 100}{\Delta V_{IN} \cdot V_{OUT(S)}}$	Voltage Regulation	$I_{OUT} = 40\text{mA}$ $5.0\text{V} \leq V_{IN} \leq 10.0\text{V}$	—	0.2	0.3	%/V
V_{IN}	Input Voltage		—	—	10.0	V
$\frac{\Delta V_{OUT(A)}}{V_{OUT(S)} \cdot \Delta T_A}$	Temperature Coefficient of Output Voltage	$I_{OUT} = 40\text{mA}$ $-40^\circ\text{C} \leq T_A \leq 85^\circ\text{C}$	—	± 100	—	ppm/ $^\circ\text{C}$
	Long Term Stability	$T_A = 125^\circ\text{C}$, 1000 Hours	—	0.5	—	%

1 μ A LOW DROPOUT POSITIVE VOLTAGE REGULATOR

TC55 Series

TC55RP30 ELECTRICAL CHARACTERISTICS: $V_{OUT(S)} = 3.0V$, $T_A = 25^\circ C$ unless otherwise specified (see REMARKS).

Symbol	Parameter	Test Conditions	Min	Typ	Max	Unit
$V_{OUT(A)}$	Output Voltage	$I_{OUT} = 40mA$ $V_{IN} = 4.0V$	— 2.94	— 3.0	— 3.06	V
I_{OUTmax}	Maximum Output Current	$V_{IN} = 4.0V$, $V_{OUT(A)} \geq 2.7V$	150	—	—	mA
ΔV_{OUT}	Load Regulation	$V_{IN} = 4.0V$, $1mA \leq I_{OUT} \leq 80mA$	—	45	90	mV
V_{dif}	I/O Voltage Difference	$I_{OUT} = 80mA$ $I_{OUT} = 160mA$	— —	180 400	360 700	mV
I_{SS}	Current Consumption	$V_{IN} = 4.0V$	—	0.9	2.8	μA
$\frac{V_{OUT(A)} \cdot 100}{\Delta V_{IN} \cdot V_{OUT(S)}}$	Voltage Regulation	$I_{OUT} = 40mA$ $4.0V \leq V_{IN} \leq 10.0V$	—	0.2	0.3	%/V
V_{IN}	Input Voltage		—	—	10.0	V
$\frac{\Delta V_{OUT(A)} \cdot 10^6}{\Delta T_A \cdot V_{OUT(S)}}$	Temperature Coefficient of Output Voltage	$I_{OUT} = 40mA$ $-40^\circ C \leq T_A \leq 85^\circ C$	—	± 100	—	ppm/ $^\circ C$
	Long Term Stability	$T_A = 125^\circ C$, 1000 Hours	—	0.5	—	%

MARKING

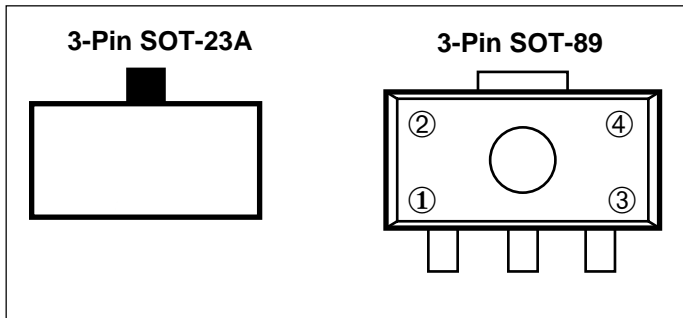

1 μ A LOW DROPOUT POSITIVE VOLTAGE REGULATOR

TC55 Series

TYPICAL CHARACTERISTICS

1. OUTPUT VOLTAGE vs. OUTPUT CURRENT

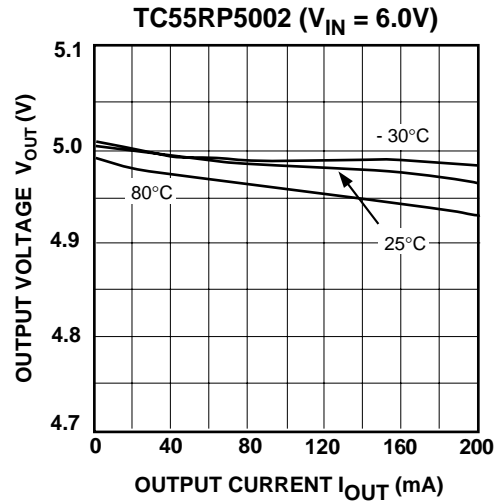
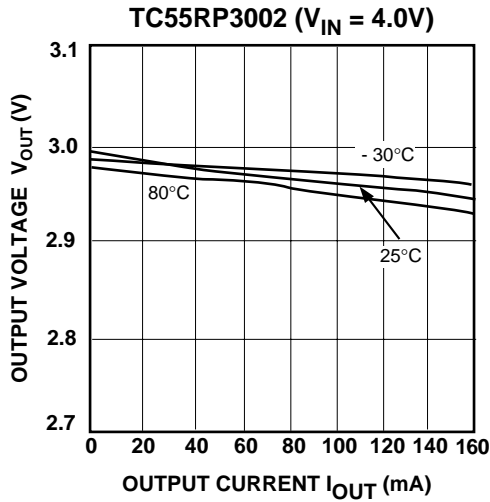

2. OUTPUT VOLTAGE vs. INPUT VOLTAGE

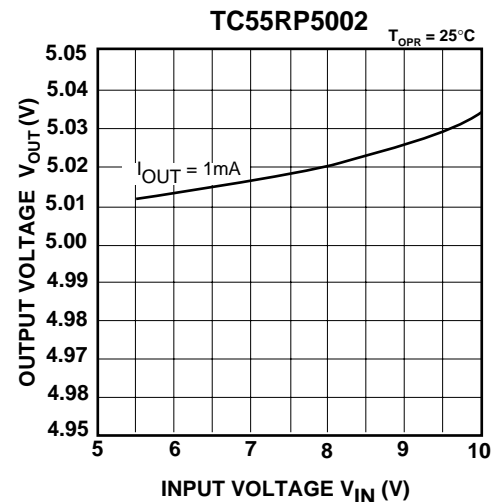
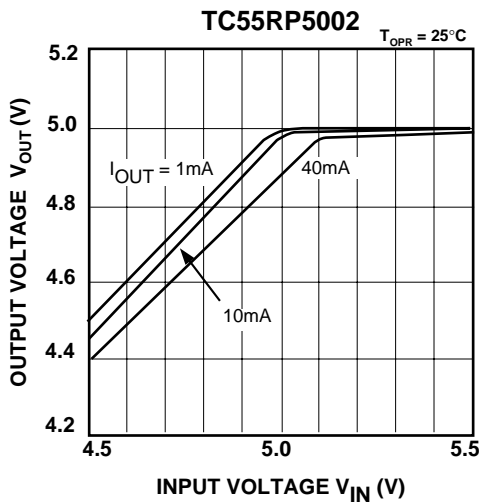
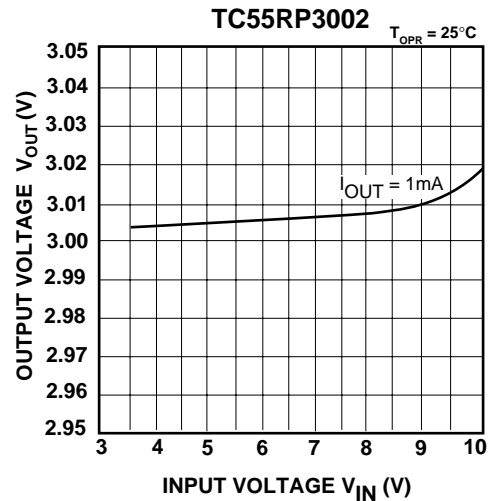
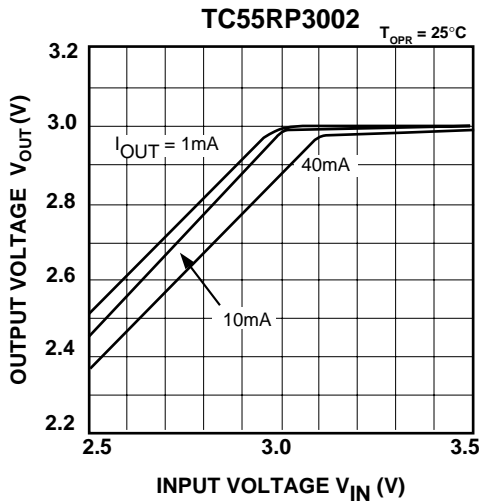

1 μ A LOW DROPOUT POSITIVE VOLTAGE REGULATOR

TC55 Series

TYPICAL CHARACTERISTICS

3. DROPOUT VOLTAGE vs. OUTPUT CURRENT

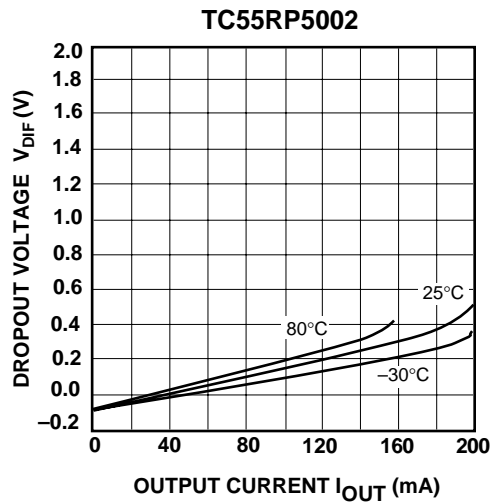
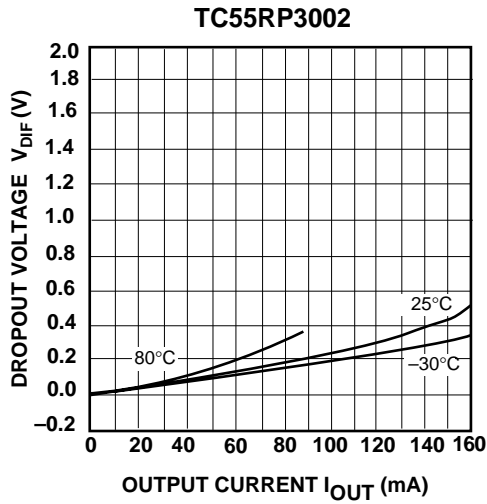

4. OUTPUT VOLTAGE vs. OPERATING TEMPERATURE

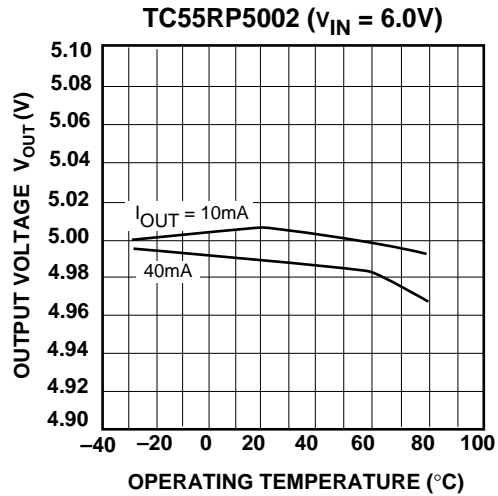
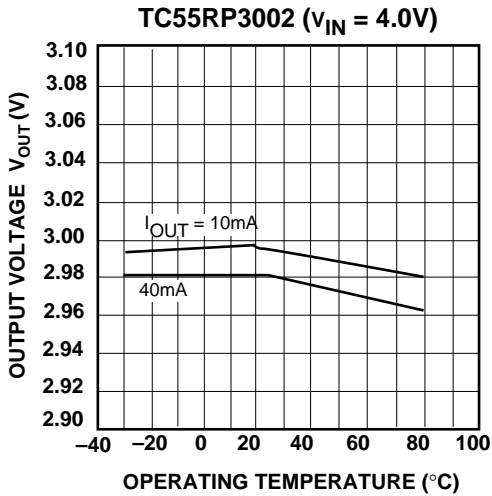

5. SUPPLY CURRENT vs. INPUT VOLTAGE

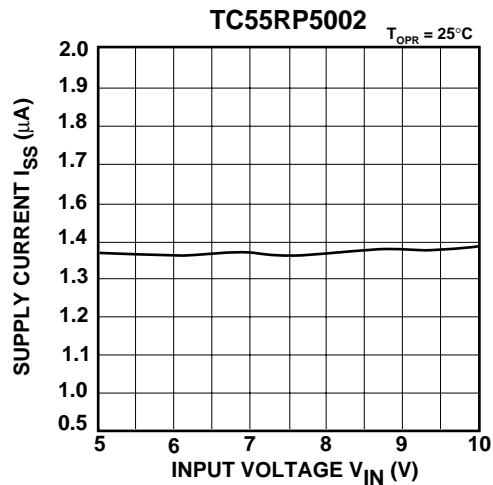
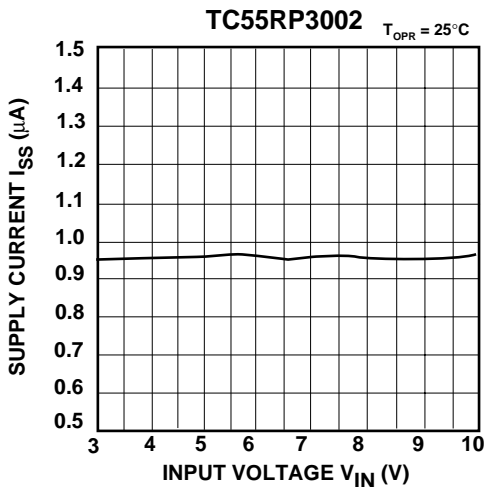

1 μ A LOW DROPOUT POSITIVE VOLTAGE REGULATOR

TC55 Series

TYPICAL CHARACTERISTICS

6. SUPPLY CURRENT vs. OPERATING TEMPERATURE

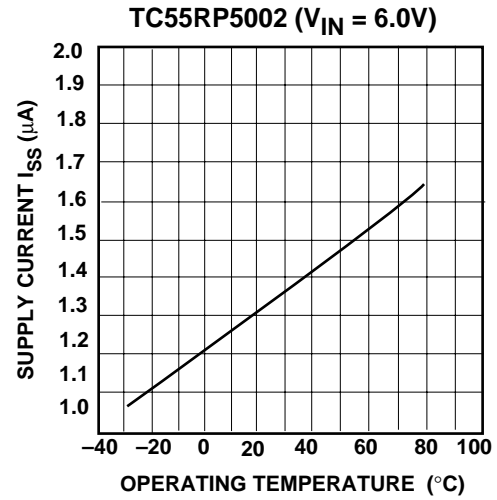
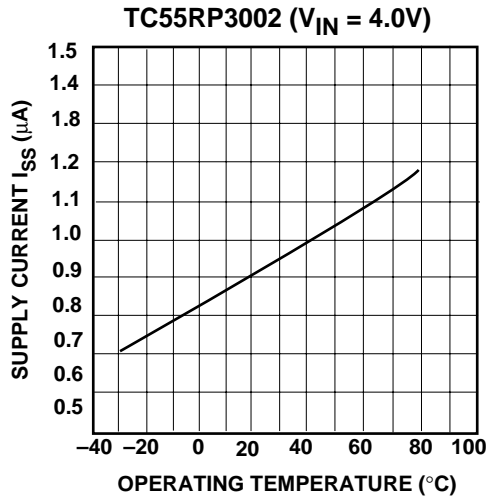

7. INPUT TRANSIENT RESPONSE

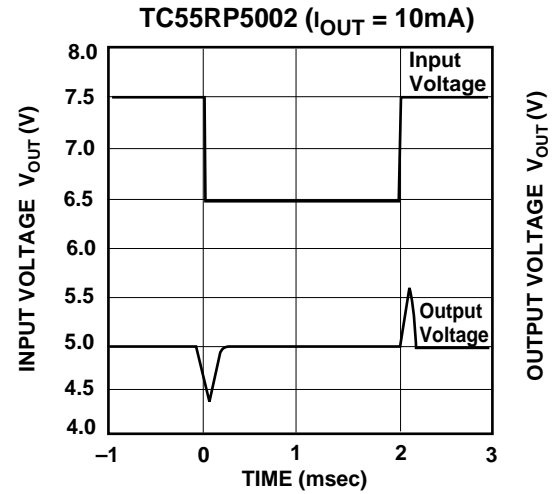
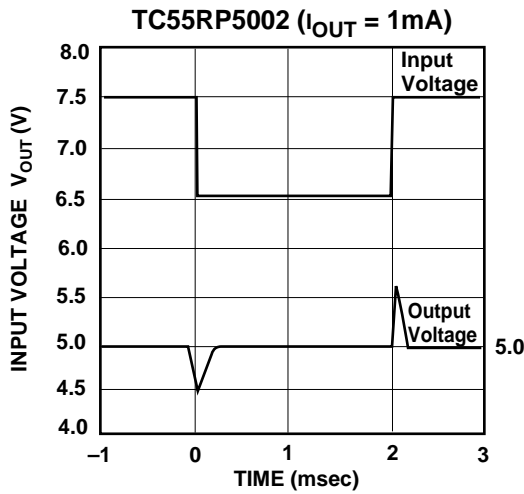

TAPING FORMS

Component Taping Orientation for 3-Pin SOT-23A (EIAJ SC-59) Devices

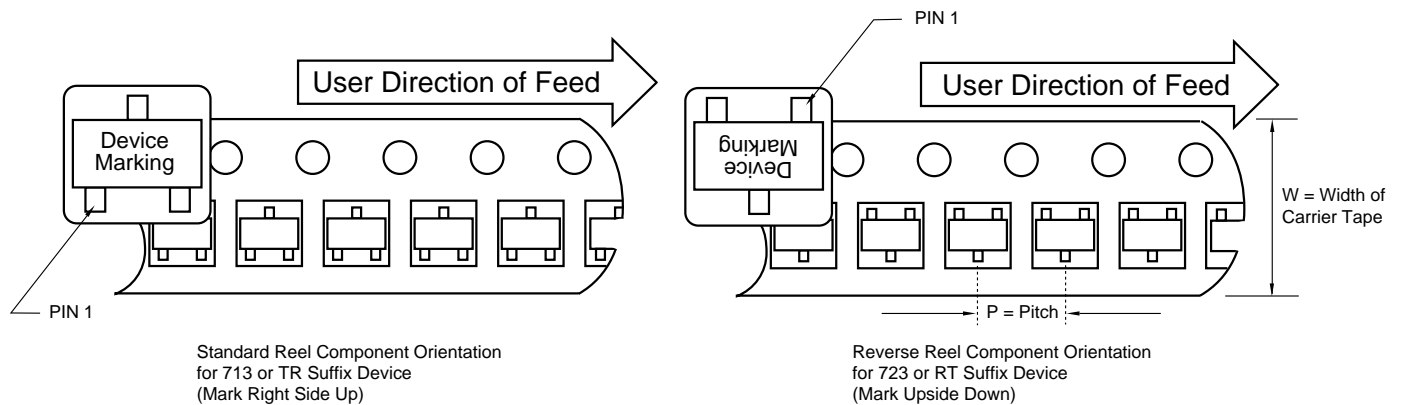

Carrier Tape, Reel Size, and Number of Components Per Reel

Package	Carrier Width (W)	Pitch (P)	Part Per Full Reel	Reel Size
3-Pin SOT-23A	8 mm	4 mm	3000	7 in

Component Taping Orientation for 3-Pin SOT-89 Devices

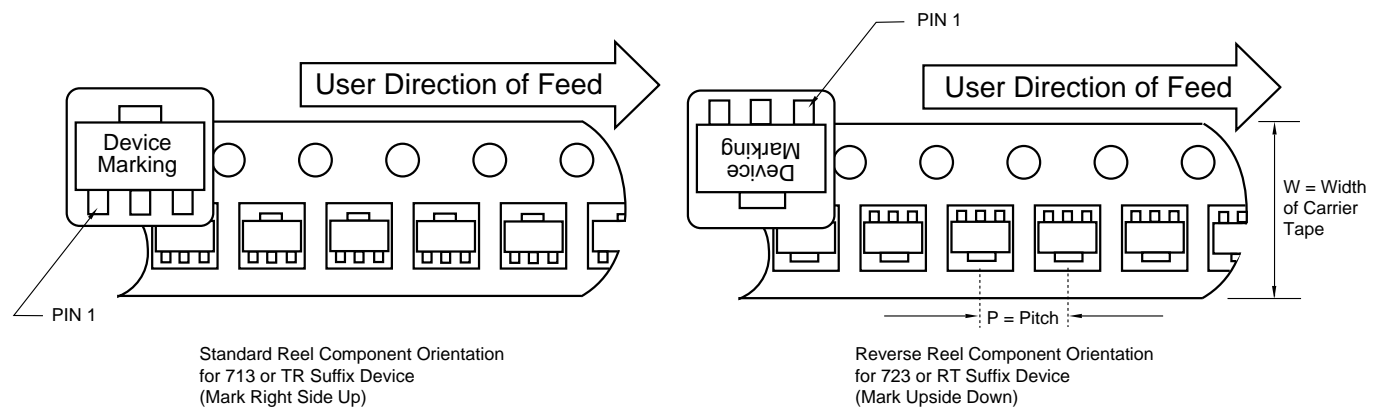

Carrier Tape, Reel Size, and Number of Components Per Reel

Package	Carrier Width (W)	Pitch (P)	Part Per Full Reel	Reel Size
2-Pin SOT-89	12 mm	8 mm	1000	7 in

1 μ A LOW DROPOUT POSITIVE VOLTAGE REGULATOR

TC55 Series

TAPING FORMS (Cont.)

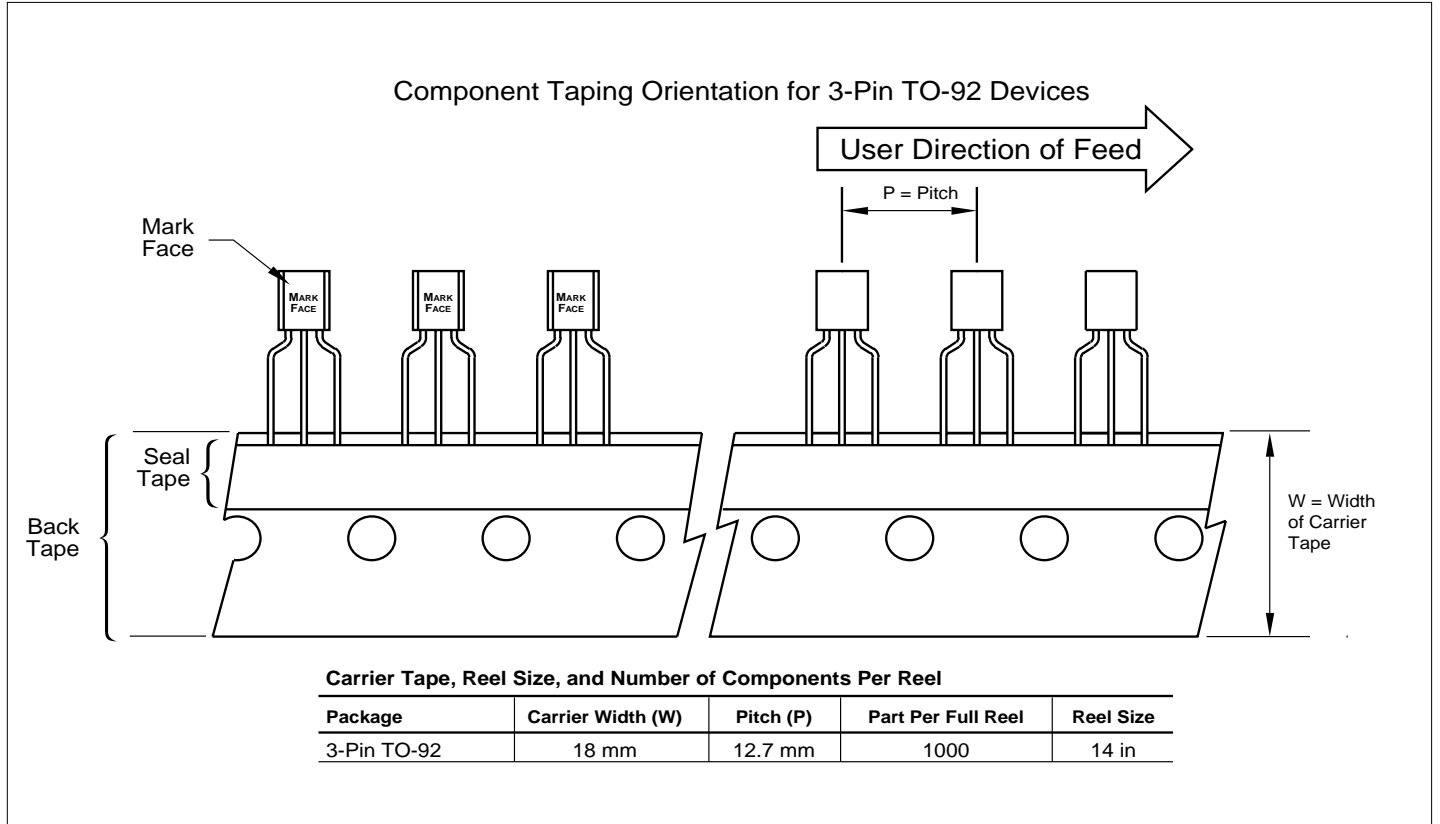

PACKAGE DIMENSIONS

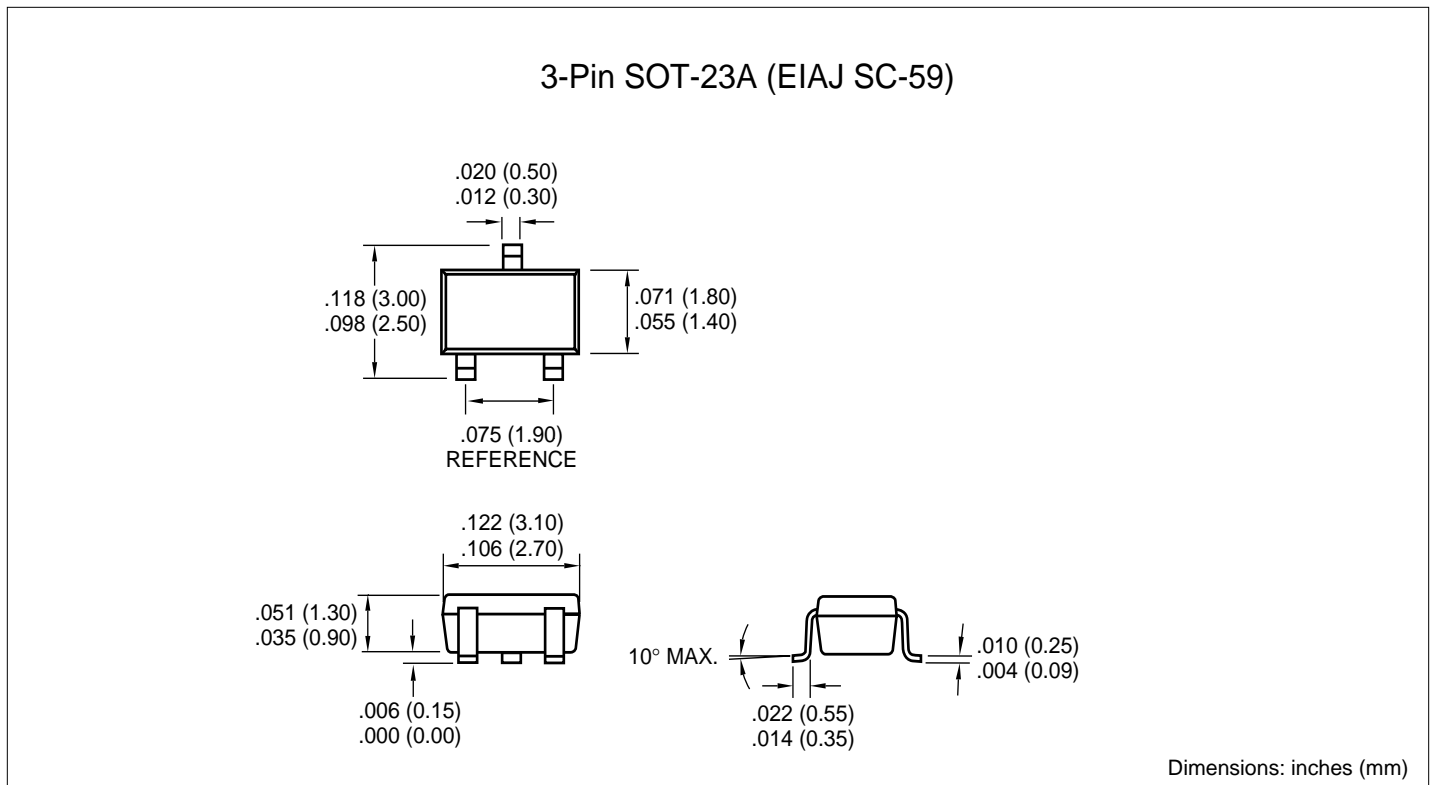

1 μ A LOW DROPOUT POSITIVE VOLTAGE REGULATOR

TC55 Series

PACKAGE DIMENSIONS (CONT.)

3-Pin SOT-89

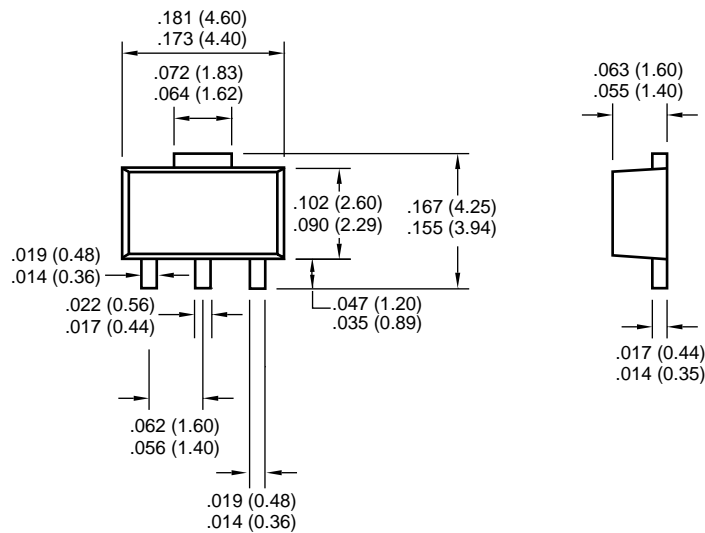

3-Pin TO-92

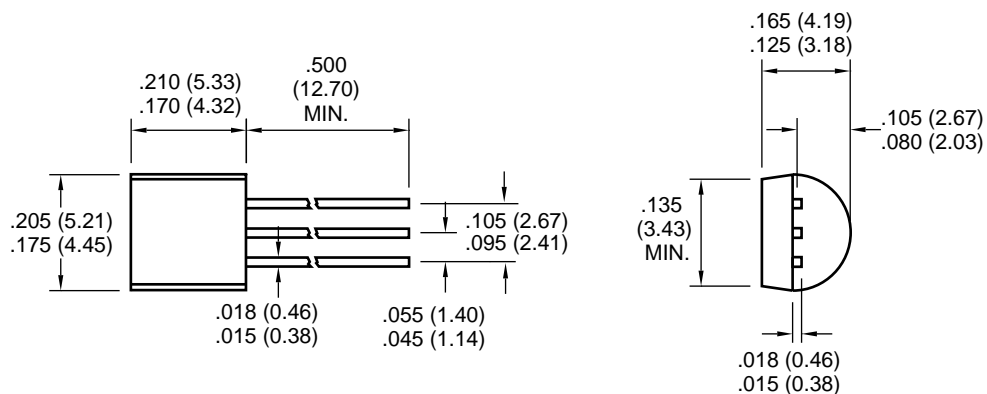

Dimensions: inches (mm)

Sales Offices

TelCom Semiconductor, Inc.
 1300 Terra Bella Avenue
 P.O. Box 7267
 Mountain View, CA 94039-7267
 TEL: 650-968-9241
 FAX: 650-967-1590
 E-Mail: liter@telcom-semi.com

TelCom Semiconductor, GmbH
 Lochhamer Strasse 13
 D-82152 Martinsried
 Germany
 TEL: (011) 49 89 895 6500
 FAX: (011) 49 89 895 6502 2

TelCom Semiconductor H.K. Ltd.
 10 Sam Chuk Street, Ground Floor
 San Po Kong, Kowloon
 Hong Kong
 TEL: (011) 852-2350-7380
 FAX: (011) 852-2354-9957